

January 2013

Vapor-Liquid-Solid(VLS) Grown Silica (SiO_x) Nanowires as the Interface for Biorecognition Molecules in Biosensors

Eduardo Murphy-Pérez

University of South Florida, eduardomurhyperez@gmail.com

Follow this and additional works at: <http://scholarcommons.usf.edu/etd>

 Part of the [Biomedical Engineering and Bioengineering Commons](#), and the [Electrical and Computer Engineering Commons](#)

Scholar Commons Citation

Murphy-Pérez, Eduardo, "Vapor-Liquid-Solid(VLS) Grown Silica (SiO_x) Nanowires as the Interface for Biorecognition Molecules in Biosensors" (2013). *Graduate Theses and Dissertations*.
<http://scholarcommons.usf.edu/etd/4549>

This Dissertation is brought to you for free and open access by the Graduate School at Scholar Commons. It has been accepted for inclusion in Graduate Theses and Dissertations by an authorized administrator of Scholar Commons. For more information, please contact scholarcommons@usf.edu.

Vapor-Liquid-Solid (VLS) Grown Silica (SiO_x) Nanowires as the Interface for
Biorecognition Molecules in Biosensors

by

Eduardo Murphy-Pérez

A dissertation submitted in partial fulfillment
of the requirements for the degree of
Doctor of Philosophy
Department of Electrical Engineering
College of Engineering
University of South Florida

Co-Major Professor: Shekhar Bhansali, Ph.D.
Co-Major Professor: Wilfrido A. Moreno, Ph.D.
Paris H. Wiley, Ph.D.
Andrew M. Hoff, Ph.D.
Mark J. Jaroszeski, Ph.D.

Date of Approval:
March 22, 2013

Keywords: Glucose Oxidase, Cyclic Voltammetry, Nanostructures, Electrophoresis,
Silanes

Copyright © 2013, Eduardo Murphy-Pérez

Dedication

To my big family in Mexico (the Pérez and the Murphy) and the smaller one in the United States, to my friends: the old ones, the new ones, and those lost along the way. To my girlfriend, Sandra Adriana Dorantes Quintero, and my grand aunt, Dr. Ruth Walsh, who just recently passed away. I will never forget the conversations and the beers that she always had in the fridge for me.

Acknowledgments

I would like to express my gratitude to both my co-major professors: Dr. Bhansali whom supported me and allowed to form part of his group, and Dr. Moreno whom helped me out in many different occasions and got me out of “interesting” situations. Very special thanks go to Dr. Bhansali’s group; Eric Huey, for the SiO_x nanowires fabrication and all his help using the electron microscope; Frank Alexander, for his teachings and help; Dorielle Price, for support both writing/technical; Michael Celestin, for his tech support; Rudraskandan Ratnaduri, for his lab help; Sheila Jean and Marcia Balaguera, for their lab friendship; Dr. Sunil Arya, for all his teachings; and the rest of the bioMEMS group: Kevin Luongo, Dr. Al-Ahkir Rogers, Dr. Subramanian Krishnan, Dr. Shankar Koiry, Hayde Silva, Abhisheck Dey, Abhay Vasudek, Justin Boone. In addition, great appreciation to: Dr. José Rey, Dr. Jeffy Jimenez, Dr. Georgina Rosas, Lou-Ella Alexander, Jennifer Courel, Dr. Chris L. Frewin, Dr. Chris Locke, Dr. Norelli Schettini, Alexandra Oliveiros, Rosita and Dr. Ruggero Anzalone, and Dr. Chamila Siyambalapitiya, Michael Konrad, Ivan Rivera, Leigh West, Dr. Norma Alcantar, Mr. Bernard Batson, Dr. Rafael Pérez, Gayla Montgomery, Irene Spunde, Catherine Burton, Susanna Pérez, Dr. Emirov Yusuf and Robert Tufts. Very special thanks to Jason Carabelli from the writing center at USF.

Table of Contents

List of Tables	iii
List of Figures	iv
Abstract	vi
Chapter 1: Introduction	1
Chapter 2: Background.....	3
2.1. Bioelectronics	3
2.2. Nanotechnology in Bioelectronics	4
2.3. Biosensor Definition	5
2.4. Biorecognition Agents	7
2.4.1. Antibodies	11
2.4.2. Aptamers.....	14
2.4.3. Enzymes	16
2.4.4. Lectins.....	18
2.4.5. Whole Animal or Plant Cells.....	18
2.5. Interface/Biomatrix	21
2.5.1. Nanowire Modification and Implementation.....	23
2.5.2. Protein Functionalization	25
2.6. Surrounding Media.....	27
2.6.1. Buffers.....	28
2.7. Detection Methodologies	29
2.7.1. Mediators	31
2.8. Design of Experiments (DOE).....	33
Chapter 3: Approach	34
3.1. Electrode Fabrication	34
3.2. SiO _x	35
3.3. Depositing Nanowires	38
3.4. Binding Proteins to SiO _x Nanowires	41
3.5. Glucose Oxidase (GOx).....	45
3.6. DOE Approach.....	46
Chapter 4: Characterization and Experiments	48
4.1. Cyclic Voltammetry Characterization of the Electrodes	48

4.2. Cyclic Voltammetry Glucose Sensing	55
4.3. Cyclic Voltammetry Temperature and pH Studies	57
4.4. Design of Experiments.....	60
Chapter 5: Conclusions	65
5.1 Future Work	66
References	68
Appendices.....	76
Appendix A: The Potentiostat System	77

List of Tables

Table 1	Classification of nanostructures.....	21
Table 2	Examples of oxides used in biosensing applications	23
Table 3	Chemical modifications in different surfaces.....	25
Table 4	General review of working principles in electrochemical techniques	30
Table 5	Sample parameters used for EP and DEP experiments	39
Table 6	Main governing mass transport phenomena in liquids.....	53
Table 7	Factors in the Randle-Sevcik equation	54
Table 8	Factor description for the DOE	60
Table 9	Proposed DOE	60

List of Figures

Figure 1	The main elements in biosensors.....	6
Figure 2	Classification of biosensors by recognition agents.....	8
Figure 3	The reaction mechanism of electro catalytical proteins.....	9
Figure 4	The ELISA methodology.....	10
Figure 5	Schematic of an IgG antibody.....	12
Figure 6	Antibody production for science and industry.....	13
Figure 7	Creating aptamers though the SELEX process.....	15
Figure 8	Cell based biosensors.....	20
Figure 9	Dimensionality classification.....	22
Figure 10	Chemical and physical separation of nanowires.....	24
Figure 11	Amino acid basic conformation and peptide formation.....	26
Figure 12	Protein denaturalization.....	29
Figure 13	Electron pathway using mediators.....	32
Figure 14	Schematic of the electrode fabrication.....	35
Figure 15	Example of the VLS mechanism for nanowires growing.....	37
Figure 16	Moving nanoparticles across electric fields.....	38
Figure 17	Depositing SiO _x nanowires through electrophoresis.....	39
Figure 18	Different volumes of nanowire deposition.....	40
Figure 19	Silanization process.....	41

Figure 20	Chemical binding between a silanized surface and a protein	42
Figure 21	TEM of glucose oxidase and SiO _x nanowires	44
Figure 22	From glucose to gluconic acid	45
Figure 23	The four basic steps in the biochip creation	47
Figure 24	Parameters to be changed in the DOE approach	47
Figure 25	The three electrode cell system.....	49
Figure 26	CV characterization of the bare Au electrode	51
Figure 27	CV of the Au electrode with the NW deposition	51
Figure 28	CV of the silanized NW on top of the Au electrode.....	52
Figure 29	CV of the final modified electrode, glucose oxidase conjugated.....	52
Figure 30	Comparison between the 4 previous results at 50 mV/s.....	54
Figure 31	Glucose sensing	56
Figure 32	Linear relationship between glucose concentration/detection	57
Figure 33	Temperature studies.....	58
Figure 34	Arrhenius plot	59
Figure 35	pH studies	59
Figure 36	Distance variation in the new cell	62
Figure 37	A subset test experiment of the DOE	63
Figure A	Electrical model of the potentiostat system	77
Figure B	The difference between two and three electrodes	78
Figure C	The oxidation peak of mediators in CV measurements.....	79
Figure D	The reduction peak of mediators in CV measurements	80

Abstract

Biosensors are analytical devices that can be integrated in numerous applications in fields such as: medical, defense, pharmaceutical, biological or forensic sciences just to name a few. Most of these biosensors have a surface that can be nano or micro fabricated. This surface is of great importance, because it provides the mechanical support of the biorecognition proteins, capable of sensing whether or not a certain analyte is present in the surrounding media. The surface characteristics will require certain physical and chemical properties in order to create an effective biosensor.

In this dissertation, one-dimensional silicon oxide or silica-w nanowires (SiO_x), with good physical and chemical qualities for interfacing proteins, are being proposed for the design, fabrication, and test of a novel glucose biosensor. The biorecognition protein is the glucose oxidase enzyme, which binds perfectly with glucose, rendering two electrons after each molecular decomposition.

To bind the glucose oxidase to the silica-w nanowires, organosilane agents were used such as the 3-aminopropyltriethoxysilane (APTES), and protein termination was activated by the following zero-length crosslinkers: 1-ethyl-3-(3-dimethylaminopropyl) carbodiimide (EDC) and N-hydroxysuccinimidyl esters (NHS), which is known as the EDC-NHS chemistry.

To detect glucose concentrations, Cyclic Voltammetry (CV) is used through a three electrode cell system (Ag/Cl reference electrode). The mediator in this experiment is the ferro+ferricyanide couple. CV is again used with Focussed Ion Beam (FIB), Infrared Spectra (FTIR), Scanning Electron System (SEM) to characterize the electrode surface. The Design of experiments (DOE) methodology is used not only to determine the most important process parameters, but also to optimize sensor fabrication and enhance device sensitivity in future work.

Chapter 1: Introduction

Bioscience is an out yielding and profitable expanding technology involved in several fields of work, from forensics to energy harvesting. One growing field today in science is the one based on biosensors. These new biosensors can be seen essentially as an amalgam between nature and science, and their purpose is to provide detection means for organic and inorganic compounds. Recently the integration of nanostructures as part of their design, mainly in their working area surface, have considerably increased biosensor detection limits. The working area surface is very closely related to sensitivity and many other factors that improve quality of the final product. With the aforementioned in mind, different nanomaterials are being investigated [1-3] to render biosensors that are biocompatible, easy to work with and attempt to reduce production costs. In this work, this is also the motivation behind choosing and investigating SiO_x nanowires, which are relatively easy to synthesize and modify with organosilane chemistries, for posterior organic binding. In addition, these NWs also possess other key properties, like large surface to volume ratio, mechanical stability, tunneling effects, as well as biomimicking properties.

One of the first experiments in biosensors (1962 by Clark and Lyons) was on glucose sensing. The importance of glucose detection is paramount today for confronting diabetes mellitus type I and II. A tight monitoring of blood glucose

levels could help diabetic patients to determine the appropriate time for increasing their insulin. Glucose sensing has become one of the most experimented and studied subjects (in biosensors). An advantage of working with glucose oxidase brings the availability of all this research literature. It is also important to notice that this enzyme is the most used to detect glucose.

The successful integration of this well-known protein using SiO_x NWs as the immobilization biomatrix will prove that these NWs are in fact a feasible option for biorecognition purposes. Under this consideration they will be used as the biomatrix for the bio recognition protein and will be chemically modified and then tested to see if they are able to recognize and sense glucose. The design of experiments methodology will determine which characteristics on the biosensor fabrication are the most desired to optimize quality. In summary, this research encompasses some of the most common and used chemical based processes for protein assembling, as well as detection techniques that can be used in biosensors. The next chapter will lay the foundations of the most basic aspects of such an overwhelming field.

Chapter 2: Background

This chapter will explore some of the most common and basic concepts in biosensor technology and it also explores the methodologies used when working in biosensor design, fabrication, and characterization. Some of the stated techniques are later implemented in the next chapter where the most useful techniques will be used for the device fabrication.

2.1. Bioelectronics

Biosensing is the science that couples biomolecular structures (antibodies, bacteria, viruses, enzymes) with materials that can be human synthesized (self-assembled monolayers, nanostructures, microfabricated surfaces) in order to detect a specific product. It is under this field that bioelectronics emerges. The detection methodologies of some biosensors imply the variation of electrical currents, hence the name.

The biosensors will quantify a certain substance, compound or molecule, organic or inorganic. Such analytes are often in the submicroscopic world, viruses for example are in the 5-300 nm range. Biosensors represent an effective and low cost approach to determine whether or not such an analyte may be present. Biosensors can be found in a wide variety of areas such as:

- Criminology, where the use of enzymes, antibodies, DNA segments can identify body tracers like blood, semen or DNA, and are useful to determine the identity of criminals or victims [4].
- Food production and environmental analysis, where high levels of pesticides or metals can be detected before reaching the final consumer or ecosystem [5].
- Defense and security, where the proper and fast detection of warfare agents e.g. explosive or toxic materials may prevent human or infrastructure losses [6, 7].
- Biomedical applications, where a wide variety of viruses, bacteria, or even cancerous beacons can be screened out for diagnosis or health purposes in ill patients [8].

Biosensors comprise a profitable and expansive thriving market. The future estimations for the chemical biosensor market are \$17.3 billion by the year 2015 according to Global Industry analysis [9].

2.2. Nanotechnology in Bioelectronics

Nanotechnology enhances bioelectronics by substituting the ordinary traditional interface (metallic or plastic surfaces) by those created through nanoscience, thus increasing some of the best properties in biosensors. Sensitivity, selectivity, performance, as well as production costs, are just some of the main factors enhanced by the aid of nanostructures.

Other advantages of using nanotechnology over conventional surfaces include:

- Increased retention of the biorecognition proteins, perhaps due to their effects on the protein's secondary structure (biomimicry). This effect is not fully understood yet, and could depend on the type of protein as well as the type and form of nanostructures [10, 11].
- The surface area to volume ratio increases. This brings more attachment sites for the biorecognition agents, increasing their reactivity and enhancing the overall device performance [12].
- Different and selective surfaces can be used within the working surface area. In comparison a conventional surface can only provide just one type of specific material with determined physical and chemical zones [13, 14].

2.3. Biosensor Definition

A biosensor is an analytical device used in bioelectronics. It can detect by chemical or physical changes the presence of an organic or inorganic analyte. No matter how complicated or simplified a biosensor may be constructed, it will always have at least three basic elements. These are shown in Figure 1 and are described below:

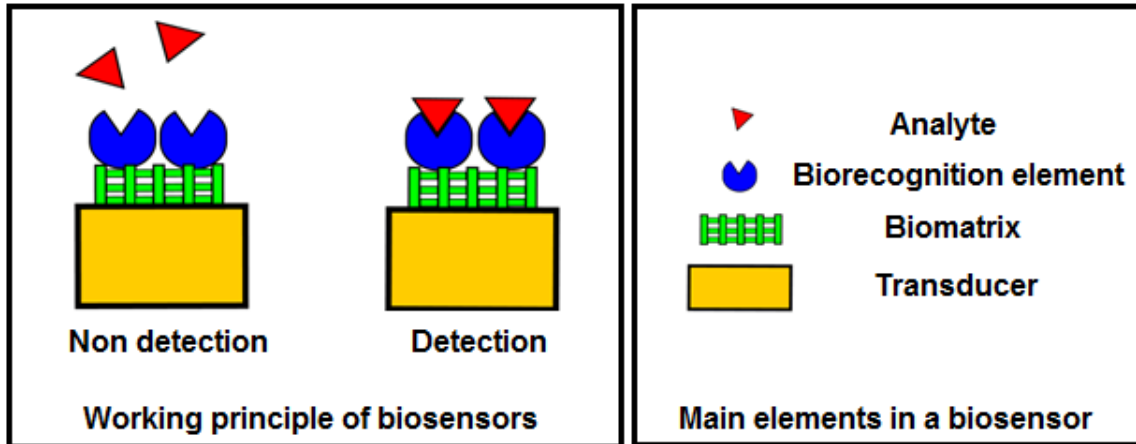

Figure 1 The main elements in biosensors

- A biorecognition element is the core unit of any biosensor. This can be obtained from natural organisms (in most cases), or it can be a specific material or compound capable of reacting with the analyte. This element is of vital importance to the biosensor, and is particularly special because it should only be selective to a single unique analyte, and produce no other reaction upon encounter with different compounds.
- The interface, often called the biomatrix, will serve as the founding structure for the biorecognition element described above. It must provide mechanical, bioaffinity, and stability to prevent isolate it from adverse effects that may be present in the surrounding media (biosensors are often immersed in liquid media). If the interface is a nanomaterial, it also may have the advantage of providing a high surface to area ratio, this implies an increase in sensitivity.
- The transducer is essential on providing a readable output from the analyte-biorecognition interaction. In some occasions the biomatrix can also serve as the transducer. In most cases the transducer consist on a metallic

surface (Au, Pt) that usually transforms the biochemical energy into electrical currents [15], or perhaps it can measure the distance variation and traduce it into a form of capacitive electrical difference [16].

2.4. Biorecognition Agents

Biorecognition agents are natural, synthesized, specialized elements. In general they are made up of 20 different “construction blocks” called amino acids. Some examples of these sort of, which are also called polymers or macromolecules, include enzymes, antibodies, and lectins. Another special case that can be used as a biorecognition agent but it is not made up of amino acids but other construction blocks called nucleotides.

The intrinsicity and complexity of the structural arrangement in some biorecognition agents confers each one its unique ability. To list some examples of the variety of different “jobs” that some of them may have:

- Storing data like the DNA/RNA. Although they are not proteins, they use nucleotides (adenine, cytosine, guanine, uracil, and thymine) to store genetic information¹.
- Moving and transporting molecules in cells to retain specific ionic concentrations. Such an example can be found in human cell membranes.

¹ As a perspective, the human genome is capable of storing 750 Mb.

- Slicing genetic information or copying it, such as the enzymes used in Polymerase Chain Reaction (PCR). These type of enzymes can even select exactly where to cut and how much.
- Catalyzing chemical reactions (e.g. the glucose oxidase enzyme). This enzyme is essential for daily energy requirements.

Science has been using some of these proteins for bio-electronic purposes, purifying and obtaining them from molds, bacteria, or animal cells. The biorecognition proteins used in biosensors can be classified upon their working nature as follows:

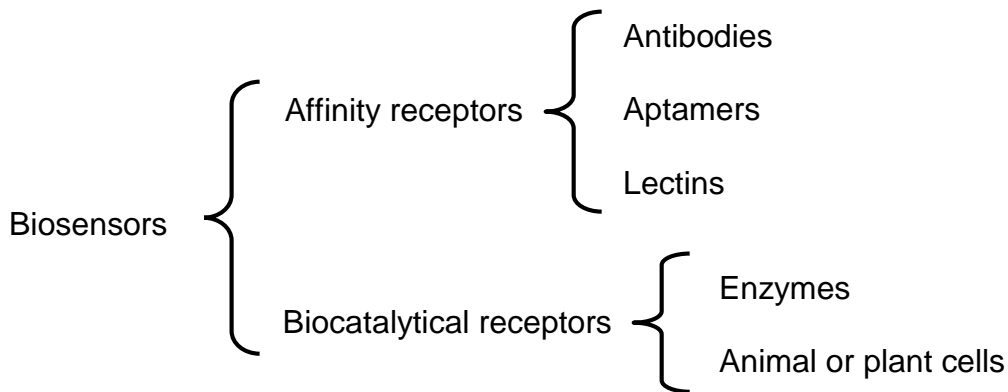

Figure 2 Classification of biosensors by recognition agents.

In biosensors with biocatalytical receptors the binding between a biorecognition protein and its analyte can be spontaneous, and once bound it is easily separated. This interaction will often generate an electrochemical reaction by converting a certain molecule into another while obtaining a variation in ions in the surrounding media (may gain or lose electrons).

To detect the presence of an analyte, these sensors can use electrochemical or optical methods. In the case of the electro catalytical enzymes, their working process is exemplified in Figure 3.

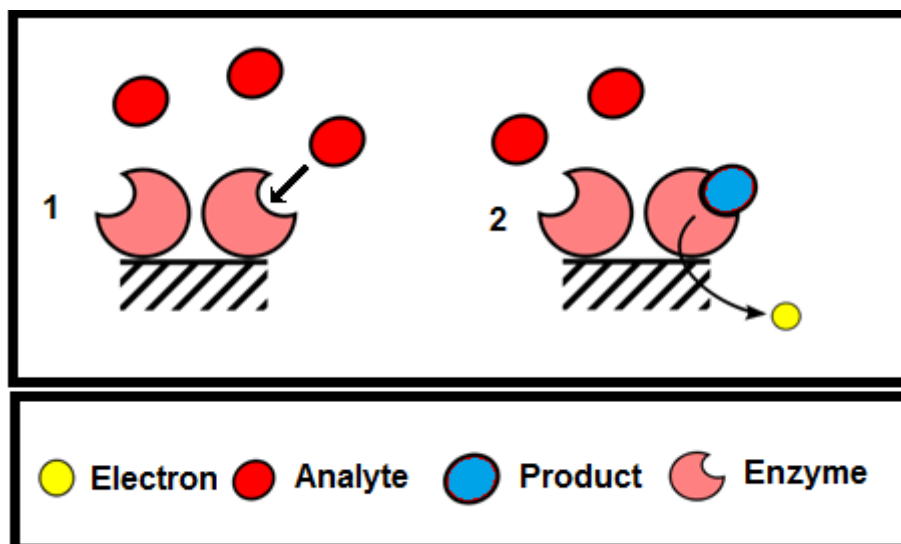

Figure 3 The reaction mechanism of electro catalytical proteins

In the figure above, the electro catalytical protein is an enzyme. For further strategical uses, this enzyme will be the glucose oxidase (GOx). Deep inside this protein, there is an electro catalytical receptor capable of altering a molecule. In the pertaining case, the enzyme will transform the β -D-glucose ($C_6H_{12}O_6$) into D-glucono- δ -lactone ($C_6H_{10}O_6$) having Hydrogen Peroxide² (H_2O_2) as the by-product. This transformation will also create a variation in electrons that is transduced into a variation in electrical current.

In contrast, the affinity proteins will only bind to its specific analyte forming a strong conjugate (e.g. antibody-antigen³) that will remain very difficult to separate, and does not provide an electrochemical reaction like in the previous case. The presence or absence of the conjugate can be detected as a change in: mass, frequency, temperature, electrical, or optical properties in the surface area. A common example is the Enzyme-Linked Immunosorbent Assay (ELISA)

² Oxygen is depleted from the surrounding media.

³ The antigen is also called the analyte.

methodology [17], which is one of the oldest antibody based biodetection techniques (Figure 4). ELISA is still implemented in numerous labs around the world, and it works by creating conjugates between the target analyte, antibodies, and fluorophores. Fluorophores are molecules that are scientifically designed to emit a light. The overall idea is quite simple in fact: first, the analyte is attached to the substrate and the unbound media is washed out. Next, the fluorophores are applied and again the unbound particles are washed out. If the analyte is present in the solution, then the fluorophores react by emitting a light.

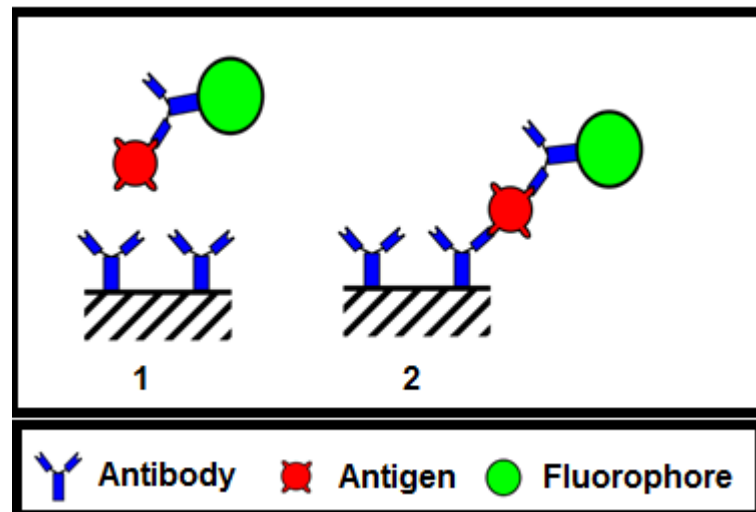

Figure 4 The ELISA methodology

Figure 4 shows the “sandwich” ELISA methodology. It relies on the use of molecular labels called fluorophores. In addition, they are bound together with a free moving antibody. The analyte is trapped between these antibodies and in doing so, the “sandwich” is created.

The ELISA methodologies often include a variety of time consuming steps that can easily lead to contamination and conclude in failed experiments. They are also very expensive due to the cost of the optical systems required for

experimentation (i.e. very specific laser wavelengths are required to excitate the fluorophores), and the fluorophore response is obtained as well under expensive microscopy methodologies. Due to the importance of both catalytic and affinity receptors, some of them will be explained next.

2.4.1. Antibodies

Antibodies are glycoproteins produced by the immune system of animal organisms, specifically by the plasma cells (B-cells). Through an evolutionary process animal organisms can produce millions of different variations that are continuously fighting against any foreign objects that enter the body. A sole human individual can have an antibody repertoire as high as 10^{16} . Such variety is essential in the immune response for disabling the wide variety of pathogens found in nature. Antibodies react to these pathogens by rendering them susceptible for macrophage obliteration, or simply by encapsulating them and stopping them from further reaction with our cells.

The usual antibody or immunoglobulin is composed of two regions: the constant region and the variable region. The constant region is designed to attach to immune cell surfaces (such as macrophages), while the variable region is the key stratagem for dealing with foreign bodies. This specificity towards a certain antagonist is the reason which science has opted to use antibodies for its own purposes. The binding area or volume of an antibody is called a paratope, the

zone of the analyte or antigen that reacts to this zone is called an epitope. When both the paratope and the epitope come together, they form the conjugate.

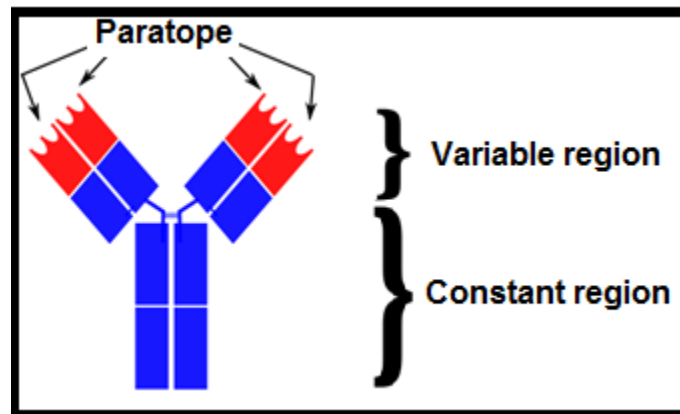

Figure 5 Schematic of an IgG antibody

These type of antibodies and many others are produced entirely by the B-cells. It is their purpose to patrol the organism and find pathogens, and if the produced antibody manages to find a couple (an antigen) then the B-cell may evolve into a plasma or memory cell. These new cells are capable of producing millions of the same antibodies and can also keep memory about previous threats to the organism. However, if the B-cell does not find any couple for its antibodies it deters and finally dies.

In 1972, antibodies gained renown through a Nobel prize experiment in which they were more easily produced and maintained. The new methodology proposed by Köhler and Milstein consisted on fusing myeloma cells (malignant plasma cells) with B-cells in order to “immortalize” them [18]. Today, the same technique is still in use, along with some other new approaches like the phage⁴ technique. The idea in the phage technology is to infect the bacteria and use it to

⁴ Phages are specialized viruses that focuses on infecting bacteria, and are used for their replicating abilities to create antibodies.

construct genetically modified viruses with antibodies attached to them. To do this, the bacteria are previously inoculated with genetically altered plasmids. Plasmids are simply “chunks” of genetic material that are copied themselves on the virus’s genetic information. When the phages infect the bacteria, they incorporate this new information into their subsequent generations. After the bacteria is dead, the new generation of viruses are created expressing the intended antibodies on top of their protein coating [19]. Both procedures are exemplified in the following schematic (Figure 6).

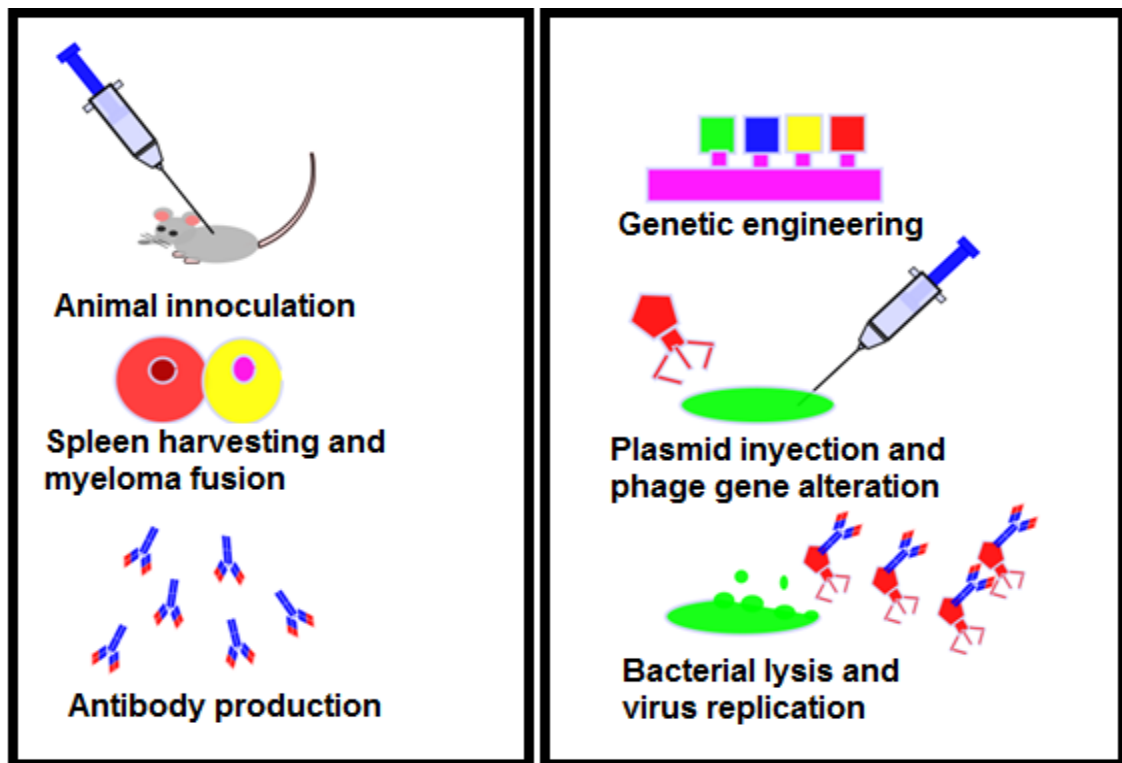

Figure 6 Antibody production for science and industry

Two different approaches in the antibody production are depicted above: the one on the left is the original method proposed by Milstein and Köhler. The antibodies are produced by first inoculating an animal with the desired pathogen, the spleen is then harvested, and B-cells producing the required antibodies are

located and purified. The B-cell is fused with a myeloma cell, which will enhance its life cycle. Afterwards antibodies are secreted by the new cell.

On the right figure, the phage display schematic is depicted. First a plasmid is introduced and affects the virus's genetic information. When the genetically modified viruses outburst from the dead bacteria, they unwillingly reproduce these genetic alterations as the intended antibodies. Antibodies are finally separated from their viruses and are ready to be used.

Antibodies are submicroscopic, their sizes are usually in the 4-15 nm range. Weighing around 150 kDa (approximately 0.249×10^{-18} grams or 0.249 atto grams). In industry and science, they are used to detect different kinds of products, both organic and also inorganic.

2.4.2. Aptamers

Aptamers are single stranded constructions of nucleic acids (oligonucleotides) produced in vitro through systematic evolution of ligands by exponential enrichment (SELEX). This technique consists of two repetitive steps: filtration and amplification. The process starts with a library of different DNA or RNA short sequences, additionally each consists on a constant fragment united with a random sequence. This random sequence is expected to react with the intended antigen. The variability in these experiments often can be as high as 10^{15} . All these different possibilities will grant the opportunity to have at least some highly attached to the desired analyte.

The second step is the amplification step. By applying PCR, a technique that uses enzymes to clone DNA or RNA sequences, the bounded aptamers will increase in quantity. The process is then repeated and only the highest affinity aptamers will prevail. The process is finished when a pure batch of highly specific aptamers has been produced, see Figure 7.

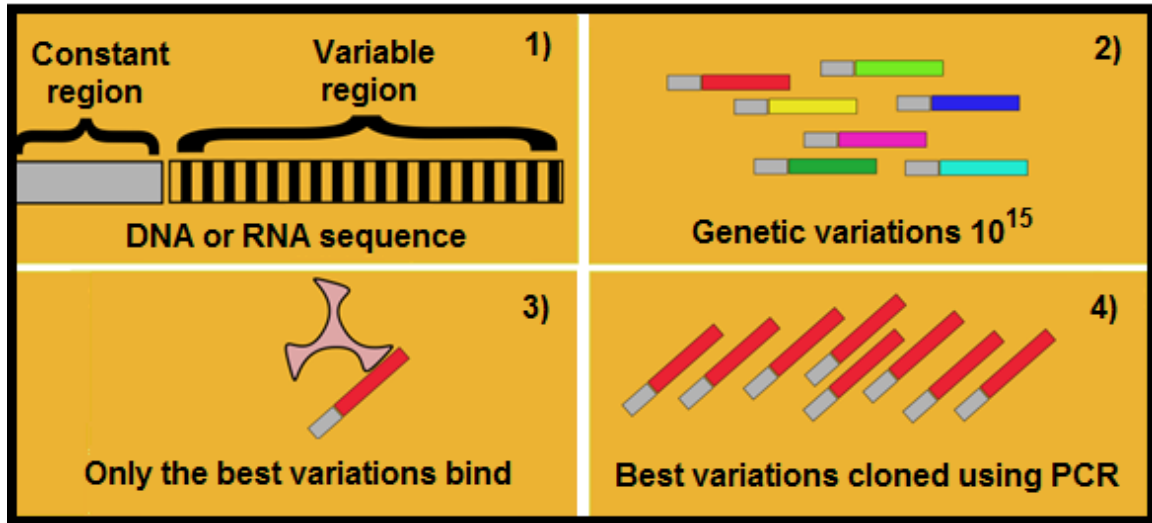

Figure 7 Creating aptamers through the SELEX process

The sequence of creating Aptamers: 1) the genetic information that can be DNA or RNA (single stranded) consists of two segments, called the constant and the variable regions. 2) there can be as much as 10^{15} variations. 3) all the genetic pool is tested against the analyte, and only the best possible option is going to bind. 4) the best possible options are cloned, and the sequence starts over again until only the best variations are rescued and purified.

The lack of animal cells to produce aptamers poses an advantage over the use of antibodies. Increased chemical stability and the capability of recognizing non immunogenic or toxic antigens is the main difference between using antibodies and aptamers. Whereas the main disadvantage when using aptamers,

is the degradation caused by different nucleases (special enzymes present in body fluids that specifically cleaves DNA or RNA apart), they degrade the aptamers reducing their shelf life and functionality. Furthermore, it is a repetitive cycle that depending on the required quality (higher quality demands more cycles) can go from 8 to 15 cycles. The amount of steps makes it prone to contamination [20].

Aptamers may have their applications specifically as biosensor compounds. Biochips or DNA matrix arrays are well known in the biosensing industry and may use aptamers [21]. Their functioning is mostly optical, although, some electrochemical cases and mechanical sensing (e.g. mass differentiation) have been reported [22].

2.4.3. Enzymes

Before talking about enzymes it is interesting to know some early history and how man used them before the modern era. Enzymes have been used since early days in human history for fermentation processes such as beer and bread making. It was in 1780 when Lazzaro Spallanzani discovered them as being part of the digestive process. Later in 1913, the equations on how enzymes behave (enzyme kinetics) were developed by Michaelis and Menten, and by the 1950's hundreds of different enzymes were identified [23]. Today they are fundamental to food, agriculture, cleaning, energy, and material industries [24].

In living organisms the use of enzymes within cells serve as a way to increase metabolic activity. In other words, cells use some specialized proteins

named enzymes that will help a cell to increase its speed in productivity, changes, and the overall efficiency that the cell may have. A common example happens everyday when consuming food. Food is decomposed into different molecules for a more easier nutritional absorption. Amidst these various decomposed molecules, the sugar molecule ($C_6H_{12}O_6$) is of vital importance for energy purposes. For harvesting this energy, a cell will oxidize the glucose molecule (sugar) producing water, carbon dioxide and energy in the aftermath.



The reaction between glucose and oxygen is then said to be catalyzed by the enzyme, and it is only one of many other reactions that may happen inside or outside the cell walls. The accelerating rates of enzymes can at some instances yield increased rate levels of certain reactions as high as 10^{21} . Enzymes, no matter their purpose, have in common three different traits:

- Catalytic power, the ratio of the catalyzed reaction over the uncatalyzed reaction.
- Specificity, the selective qualities of an enzyme towards the substance that it is acting upon (the substrate), e.g. in the equation above the enzyme is glucose oxidase and the substrate is the glucose. Glucose oxidase will only react to glucose and not any other compound (in the ideal world).
- Regulation, which refers to the way a certain enzyme can be controlled. Inhibitors and activators are just one way to regulate enzyme activity.

In order to maintain a proper function of their tasks, enzymes are often helped by non-protein components such as:

- Cofactors, mostly metal ions.
- Coenzymes, organic molecules, mainly vitamins.

Both elements can help some enzymes to do their job. As a matter of fact, without them some enzymes wouldn't be able to oxidize or reduce their specific compounds.

2.4.4. Lectins

Lectin from the latin word *legere* (to select) are proteins that have a high affinity for sugar proteins (carbohydrates). They are precipitated and are purified from different organisms like animal, mushroom or plant tissues. They can be applied in different science areas: from deterring insect and fungal activity in crops and fields, to antitumor growth as well as antivirals [25]. They also have been applied as biosensors which are mainly based on optical means of detection [26].

2.4.5. Whole Animal or Plant Cells

Whole animal or plant cells can include mammalian, fungal, bacterial, and algal cells. These will produce “x” compounds by processing the surrounding “y” compounds present in the environment. The possibility of having electrochemical reactions as well as affinity reactions is always present. These based whole cell biosensors can be present in the food, environment, energy and even as major producers of biorecognition agents (e.g. the bacteria used for the antibody

creation). The disadvantages of using whole cell based devices over other agents are:

- The loss of specificity and signal response due to the cell membrane that in some cases is not permeable. This permeability implies that the membrane in some occasions will allow the entrance to other molecules altering the cell response.
- The unwanted side reactions as there are many other biorecognition agents present in cells that may be interacting with other compounds or producing different byproducts.
- The required time and care for the correct healthy growth of different cell cultures.

As advantages, cell based biosensors have the following points:

- Self-replicating abilities, which can be used towards the creation of biofilms.
- Self-attachment to specific surfaces without the aid of chemical linkers.
- Low cost production, compared to the purified biorecognition agents, as well as a prolonged stability [27-29].

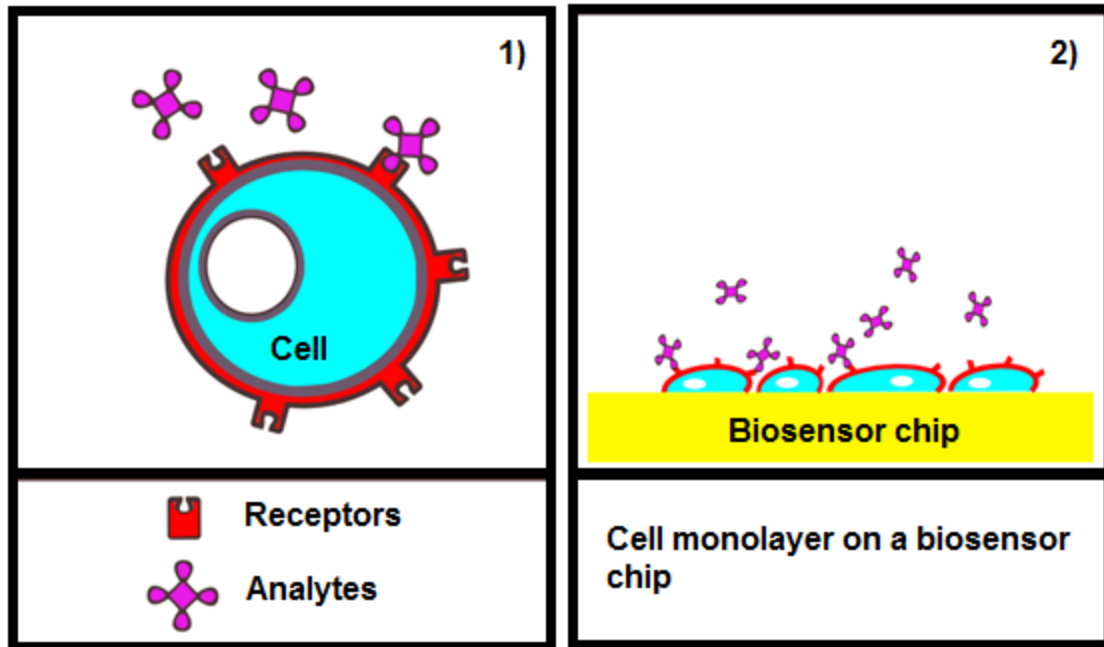

Figure 8 Cell based biosensors

In Figure 8, 1) represents a cell and their interaction with different analytes. Cells interact with a wide variety of analytes through their cellular receptors. In some cases, these receptors are natural parts of the cell. In some other instances they can be introduced through electroporation⁵ into the cell. 2) depicts how cells can be implemented as part of biosensors. Usually this happens using cell monolayers or multilayers that will interact with the analyte immersed in liquid media. When an analyte contacts the cell receptor, a change in the cell occurs, altering its mass, electrical, and even physical structure. These physical and chemical changes can be transduced as signal responses through optical, mechanical, thermal, and electrical variations.

⁵ Electroporation can introduce foreign compounds, drugs or substances into cells by applying a sudden voltage change.

2.5. Interface/Biomatrix

The biomatrix is fundamental for biorecognition proteins because it is the interface between the organic and inorganic worlds. The interface should provide a good mechanical support for the proteins as well as few cytotoxic and structural advantageous effects, such as enhancing stability and increasing the proper functioning of the organic agents (e.g. enzymes can decrease or increase their functionality depending on how well they are fixed to nanostructures) [10].

In the past, many interfaces have been made of traditional or more common materials like metallic or polymer surfaces, but the advances on nanotechnology have supplanted these. Some useful properties in nanotechnology are: high surface area to volume ratio, tunneling effects, biomimicking, and mechanical stability.

Nanostructures in science are divided in different dimensional levels. Their dimensionality depends on their size and shape. The division is shown in table 1 (adapted from 30, 31)

Table 1 Classification of nanostructures.

Classification	Examples
Zero-dimensional	Quantum dots[32], fullerenes[33], nanoparticles[34], nanolenses.
One-dimensional	Nanowires[35], nanorods[36], nanotubes[37], nanobelts[38], nanoribbons[39], nanosprings[40].
Two-dimensional	Junctions, branched structures, nanoplates, nanofilms[41], nanowalls[42], nanodisks.
Three-dimensional	Nanoballs[43], nanocoils[44], nanocones[45], nanopillars, nanoflowers[46], honey combs[47], membranes

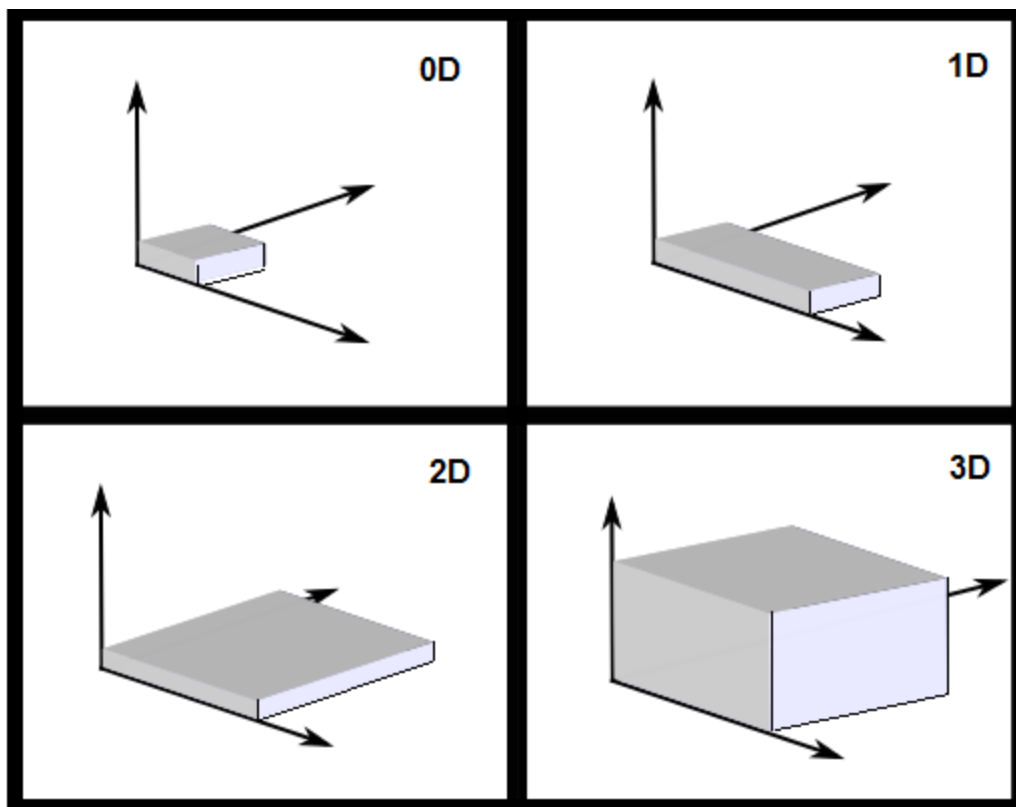

Figure 9 Dimensionality classification

Figure 9 shows the classification of different nanostructures in accordance to [30, 31]. Most of these nanostructures can be implemented for interfacing organics due to their increased surface area to volume ratio and many other interesting properties that arise in the nanoworld. All these structures can be used in bioscience as efficient biomatrices or biosensing auxiliaries (such is the case of nanoparticles). In the case of 1D nanostructures (1DNS), there is a great research interest influenced in part by the rediscovery of carbon nanotubes⁶.

So far, a variety of inorganic material 1DNS have been synthesized and characterized in other research laboratories across the world. Some of the crucial

⁶ The first documented discovery of carbon nanotubes occurred in the Soviet Union by Radushkevich and Lukyanovich in 1952, in 1991 Carbon nanotubes were again reported by Iijima, according to [48].

factors in the specific case of nanowire synthesis are the control composition, size, and crystallinity. These factors depend greatly on the selected synthesis methodology. Among the techniques employed, vapor phase techniques and solution techniques predominate.

Oxide 1DNS are another interesting material for biosensing applications. This is because the capabilities of organic functionalization is increased in such materials. The oxide layer presented on these surfaces serves as an anchor to biorecognition agents. The most used examples (adapted from [49]) along with their biosensing applications are shown in Table 2.

Table 2 Examples of oxides used in biosensing applications

Oxide material	Advantages	Matrix for immobilization of
TiO ₂	Biocompatible, photocatalysis, wide bandgap.	ChOx, GOx, lipase, HRP, IgG, DNA.
Fe ₃ O ₄	Superparamagnetism, affinity with O ₂ .	ChOx, GOx, Urs, IgG, DNA.
ZrO ₂	Biocompatible, affinity with P ₂ .	ChOx, GOx, lipase, HRP, IgG, DNA.
SiO ₂	Biocompatible, mechanical optical properties.	ChOx, GOx, lipase, HRP, IgG, DNA.
NiO	High adsorption, electron transfer	ChOx, GOx, lipase, HRP, IgG, DNA.
ZnO	Biocompatible, fast electron transfer.	ChOx, GOx, HRP, IgG, DNA.

2.5.1. Nanowire Modification and Implementation

To implement nanowires as the biomatrixes for biosensors, some modification and manipulation needs to be done first. Most of the different nanowires are available through research institutes and laboratories or can be

synthesized by the interested research group or laboratory. Depending on the case, the final form available comes in “powder” form. Nanowire synthesis often produces a high density of nanowires “bundling” together, these are termed nanowire forests. For biosensing purposes, these bundles must be previously separated or arranged in such a way that facilitates posterior matrix implementation. This separation can be achieved through chemical or physical methods.

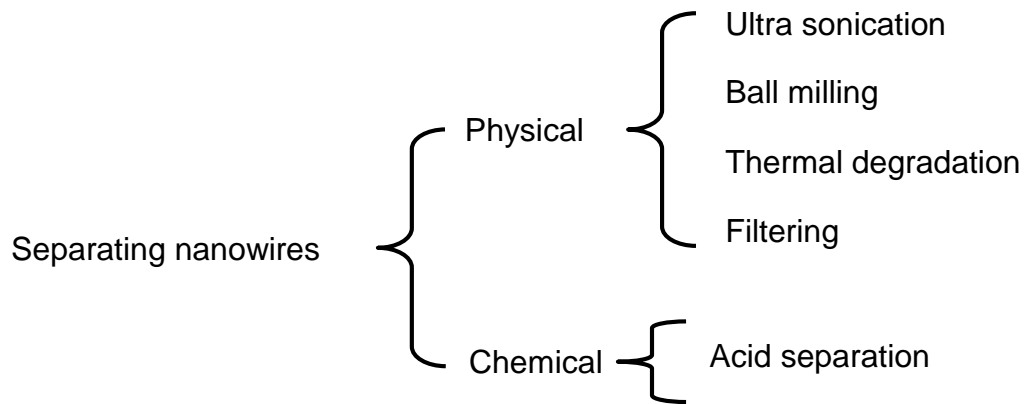

Figure 10 Chemical and physical separation of nanowires

When the nanowires are separated, they are often suspended in solvents. It is important to notice that most nanowires are insoluble in water and require other solvents. Different techniques to deposit these suspended nanowires on top of the biosensor chip exist such as dielectrophoresis [50] or electrophoresis [51].

The desired biosensor would have the nanowires attached to different surfaces: polymeric, metallic, dielectric, etc. Chemistry plays a fundamental role in knowing what kind of nanostructure can be attached to what specific surface. In our specific case of oxide nanowires, the oxide layer is the reactive part that will be functionalized to the different materials.

Table 3 Chemical modifications in different surfaces.

Surfaces	Chemistry used	References
Au	Amino thiols (sulfur groups with amine terminations)	[52]
Oxides	Amino silanes (silicon groups with amine terminations)	[53]
Any surface	Polymers (can entrap entire proteins into their structure)	[52]

2.5.2. Protein Functionalization

After the nanowires are synthesized, separated, chemically modified, and deposited on the intended surface area, they need to be chemically again modified for protein attachment. Protein functionalization is the science behind the proper attachment of protein bioagents to the desired material surface. This involves understanding the chemical terminations of both the bioagents as well as the surface. The better this interaction concurs, the better the biosensor response will be obtained. For further understanding of how a protein can be attached to a specific surface, it is typical to first analyze the biorecognition agent structure. Biorecognition proteins are usually made of the combination of 20 basic amino acids. These are essentially composed of Carbon, Oxygen, Nitrogen, Hydrogen and occasionally Sulfur. The basic structure of amino acids consists of a central carbon, called the α -carbon which is connected to four different terminations: the hydrogen, a reactive group (which creates diversification between amino acids), a carboxyl termination (COO^- , COOH), and an amino termination (NH_3^+).

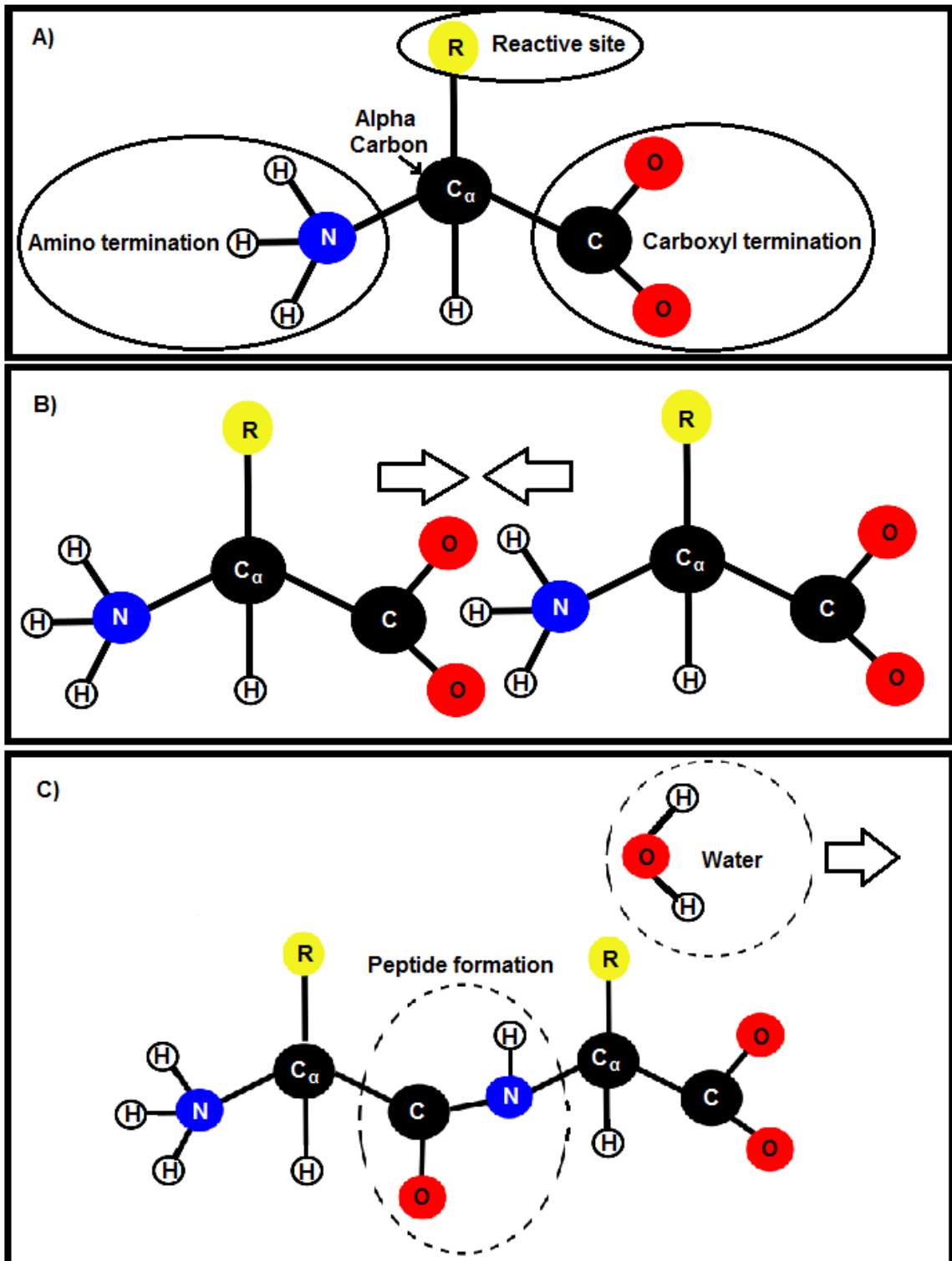

Figure 11 Amino acid basic conformation and peptide formation

Amino acids are the building blocks of proteins. Human cells use a variety of 20 amino acids to synthesize the different proteins that are needed for different purposes. A) represents the basic structure of an amino acid composed of an alpha carbon in the middle, connected to a reactive group, an amino termination, and the carboxyl termination. The reactive group is the interchangeable piece that will create the variety of amino acids. The amino part is composed of a Nitrogen with hydrogen terminations. The carboxyl part is composed of a Carbon with Oxygen terminations. B) shows how two amino acids are brought together through the electro active forces between amino and carboxyl terminations. C) shows the peptide created. When the bond is created, water escapes to the surrounding area as a byproduct.

Biorecognition agents that are made up of amino acids tend also to have this same molecular conformation. Usually the side chains (hydrophilic) of molecules are exposed while the core contains the hydrophobic residues. In bioscience this information is used to attach the bioagents to the different materials used in biosensor construction. This specific area of expertise is called bioconjugation.

2.6. Surrounding Media

It is very common to find many of the reviewed biorecognition proteins in situ, immersed in a liquid media or buffer. The adequate use of liquid media is an important factor when working with biosensors. Biorecognition capabilities are

affected, if the analytes are not present in the media due to drift or saturation problems. Another problem may arise if the temperature or pH are not adequate for proper protein-cell requirements, e.g. enzymatic cell regulation usually works in a range of 6.0 to 8.0 pH (the pH of blood is 7.38). An interesting way of countering these and many other adverse changes is using liquid solutions called buffers.

2.6.1. Buffers

Buffers are solutions that tend to resist the changes in their pH as base or acid is added to them. They are as fundamental as the correct temperature for the proper functioning of biosensors. The idea is to create the same working conditions that the bioprotein agents may encounter in nature, if these conditions are not met, denaturalization may occur. Denaturalization implies the elongation and disassembly of folded proteins (in their native state), into a large chain of amino acids that immediately loses function and effectiveness.

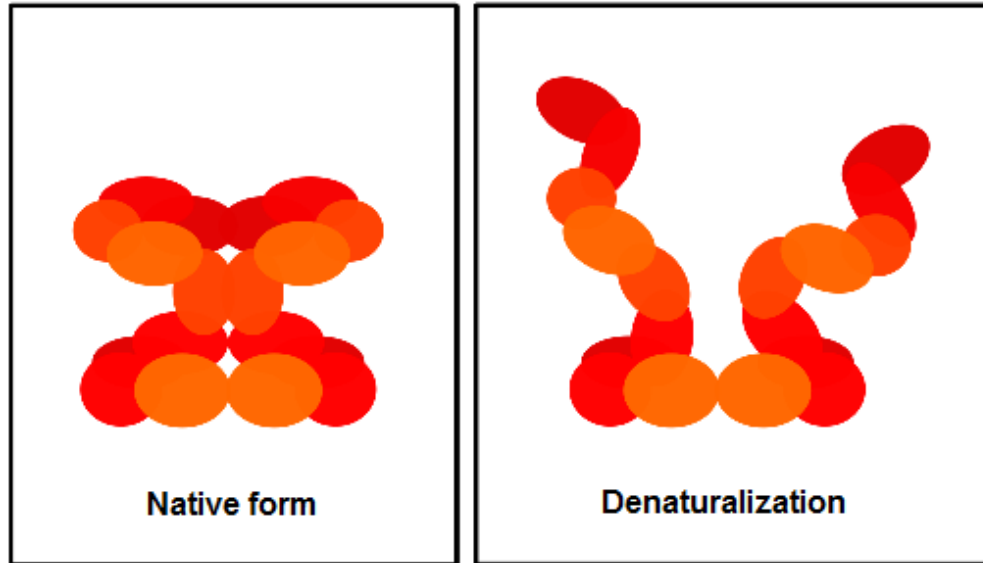

Figure 12 Protein denaturalization

Proteins depend on their complex folding to do their job properly. A change in the 3D protein structure can produce problems from specificity to correct functioning. Therefore buffers and temperature are highly relevant for stability purposes. The image above shows the difference between a folded (active) and unfolded (inactive) protein. The correct selection of a buffer for the biosensor is of vital importance.

2.7. Detection Methodologies

In biosensing, a biochemical signal is detected usually via electrochemical, mechanical, or optical techniques. As a mechanical example, antibodies can be functionalized in a micro cantilever beam. When the antibodies interact with the antigens, the microcantilever is supposed to gain molecular weight and reduce its distance with a specific surface. This deflection can then be transduced as the

detection of the analyte⁷. Laser induced fluorescence, as an example of optical methodologies, needs large-scale and expensive optical systems along with multiple preparative reagent steps. Electrochemical detection methods offer a series of advantages over the above mentioned techniques. This is because of operational simplicity, fabrication affordability, suitability for real-time detection, fewer preparative reagent steps, and flexibility in microdesign [15, 54]. Electrochemical methods are based on the reduction-oxidation reactions (redox) occurring at the surface of the working electrode. The general classification of electrochemical techniques is reviewed in Table 4.

Table 4 General review of working principles in electrochemical techniques

Technique	Working principle	Advantages	Disadvantages
Potentiometry [35]	Measures the potential developing between two electrodes without a current flowing.	Simplicity and clear principles of operation	Influenced by independent non-specific effects, only uses electro catalytical proteins.
Impedometry [36]	Combines the analysis of resistive and capacitive properties in materials.	Works using catalytical or affinity proteins	Time consuming, depending on the frequency range.
Amperometry [37]	Detection in working electrodes of a faradaic current at a constant voltage, due to the electrolysis of an electro active recognition protein.	High sensitivity in detection	Only uses electro catalytical proteins.

⁷This example is not as trivial as it may seem. Sometimes due to the nature of both organics, inorganics, and the media, the deflection can happen in the opposite direction that was originally expected [16].

Cyclic voltammetry is one of the specialized techniques in potentiometry. It has the advantage of lesser time consumption, and is also widely used in biosensors. Appendix A: The Potentiostat System gives more technical information in cyclic voltammetry and the electrode configuration used in biosensors.

2.7.1. Mediators

In the electrochemical methodologies, mediators are used in liquid media as an enhancement for electron pathways. This is often required as the redox center of an enzyme is deeply buried in the protein coating. Having access to this center is fundamental for the adequate sensing of analytes. The mediators serve as a closer pathway to carry and “steal” the required electrons for biosensing detection. A detailed explanation on the electron pathway using mediators can be found in Figure 13.

A good mediator requires:

- Fast electron transfer.
- Reversible redox behavior and low oxidation potential.
- No interaction with the enzyme that may result in modifying its functionality.

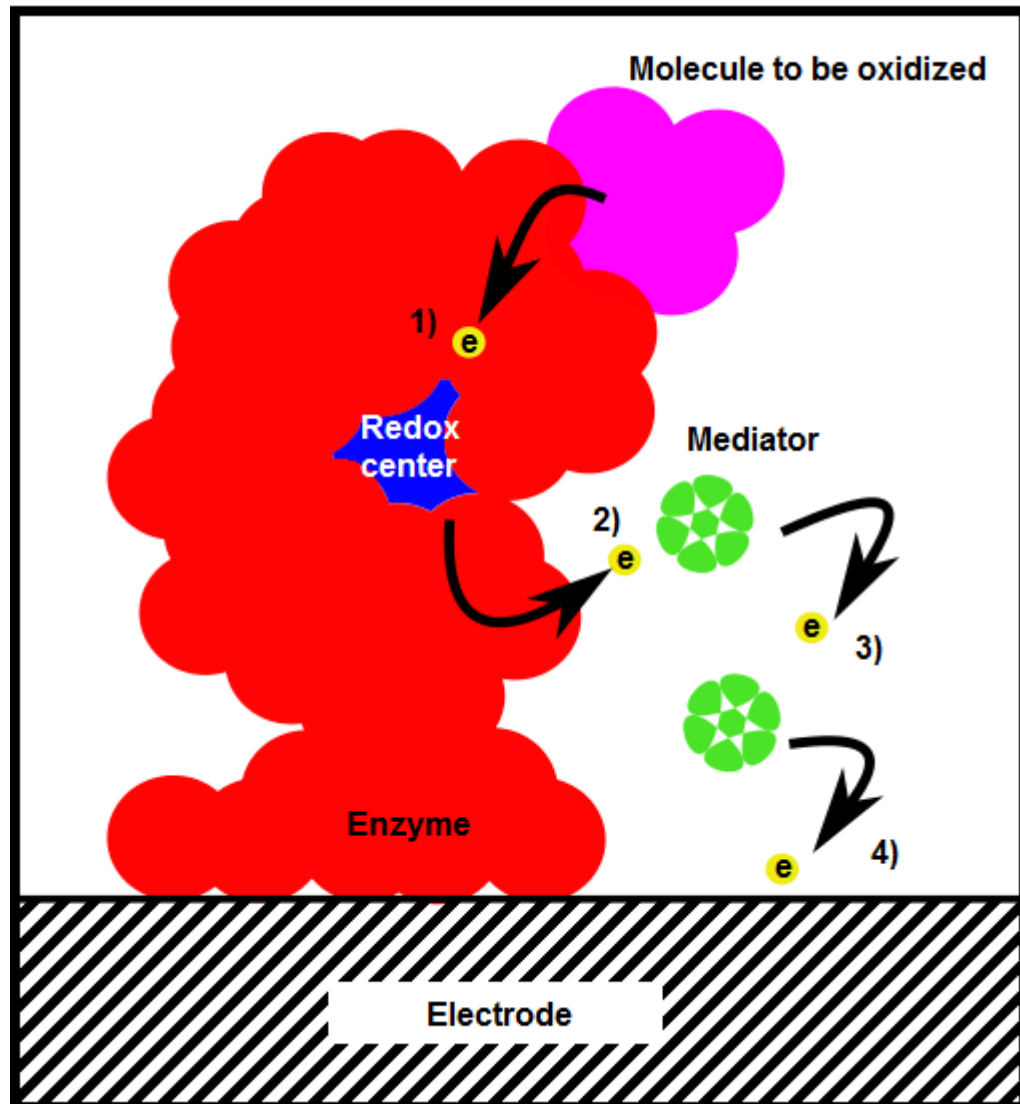

Figure 13 Electron pathway using mediators

Figure 13, shows a theorized electron pathway between enzymes and mediators[55]. 1) shows the oxidation of a certain molecule specific to the enzyme. The electron is usually taken by the redox center, which is buried inside the protein coating. 2) represents the mediator, which is taking away the electron from the redox center. 3) - 4) show the pathway created by other mediators that will direct the electron to its final destination. This flux of electrons will be transduced as a response of analyte processing by the enzyme.

2.8. Design of Experiments (DOE)

Design of Experiments (DOE) is a methodology designed to optimize the quality and efficiency of wide-ranging applications across different fields of research such as health, social sciences and engineering. DOE takes into account that the output of any experiment, the response, is usually defined by different factors or parameters. Changing these factors based on DOE techniques and then using statistical based analysis will produce a better and efficient process. This approach differs greatly from the most common one-variable-at-a-time (OVAT) experimentation. This last approach often depends on the experience and knowledge of the experimenter and can often lead to unreliable results.

DOE was first implemented in the 1920's by Sir Ronald Fisher who was at the time working at the Rothamsted Agricultural Field Research Station. He found out that crops were not only dependent on the fertilizer used, but many other factors as well, such as: moisture, soil condition, temperature, etc. DOE has different approaches based on the number of factors involved in the experiment, the interactions to be studied, and even the resources and budget allowed for the experimentation. In this work the techniques used will be based on the work of Sir Ronald Fischer, the so called classical approach.

Chapter 3: Approach

In this chapter some methodologies and techniques previously introduced are better defined and developed for the ultimate purpose of this work, the creation of a biosensor. To achieve such a task, nanostructures are used instead of conventional surfaces. These nanostructures are chemically modified to attach a certain biorecognition agent onto them. An electrochemically sensing technique determines whether or not the analyte is being recognized. Finally, DOA is implemented to determine which fabrication parameters are the most important in the biosensor creation.

3.1. Electrode Fabrication

When working with potentiometric techniques such as cyclic voltammetry, the use of metal or carbon electrodes is required. In cyclic voltammetry a three electrode system is often used⁸. Gold, Silver, Stainless Steel, Platinum and Carbon have been used as the working electrodes due to their excellent electrical, mechanical and chemical inertness properties[52]. Gold was selected as the working and counter electrodes for this biosensor experiment. Glass wafers or

⁸ The difference between a two and a three electrode cell system can be found in Appendix A: The Potentiostat System.

microscope slides are used as the substrate for the gold layer. After solvent cleaning and drying them, a thin Cr adhesion layer of 30-60 nm is deposited on the glass surface. The Au layer is then adhered to the Cr layer and usually ranges from 100 to 200 nm. Both metallic layers are deposited by electron beam in vacuum conditions (5 to 6×10^{-6} Torr). The glass slides or wafers are afterwards sliced to accommodate for rectangular individual chips of 2.5 by 0.5 cm. The electrodes are stored under dry conditions, and the next step will comprise the nanowires deposition.

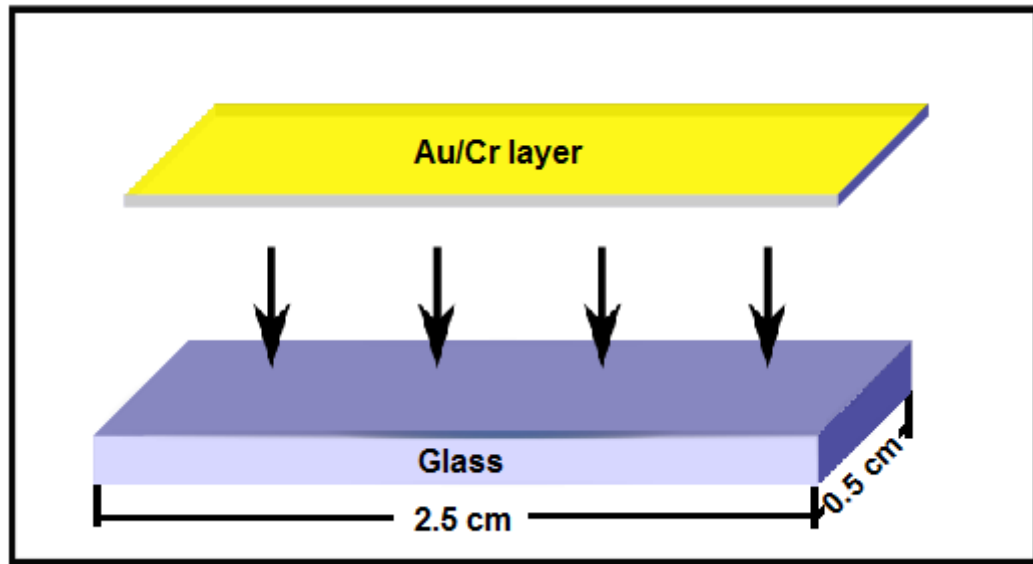

Figure 14 Schematic of the electrode fabrication.

3.2. SiO_x

After the metallic electrodes are created, the nanowires need to be deposited only on the working area. In the electrode chips, the working area is a

rectangular shape of 0.5 by 0.5 cm. Silica or Silica-W (SiO_x) nanowires⁹ are the selected 1DNS intended to work as the foundation nanostructure for the biorecognition agents. The selection of this nanowire in particular, is greatly influenced by the vast experience that the BioMEMS group at the University of South Florida has in its synthesis. SiO_x are synthesized through a possible combination of two different thermochemical techniques, however they can also be obtained from other different methods. SiO_x , where $2 \geq x \geq 1$, is a fibrous and unstable phase of silica which can change into amorphous silica due to the presence of atmospheric H_2O [56]. Found in nature, it can be synthesized into 1DNS forms through different methods of dry and wet self-assembly, which are also more generally classified as catalyst and non-catalyst based methods. The non-catalyst methods require the infusion of SiO_2 nanoparticles along with long periods of time and high temperatures (over 1000°C). While the catalyst methods, can use different kind of metal precursors (Ti, Fe, Co, Ni, Cu, Zn, Ga, Pd, In, Sn, Pt, Au), and can also achieve a better growth at lower temperatures in shorter times [56-58]. At USF, SiO_x nanowires are grown from metal catalysts Pt [59] or Pd [60] and grow through a possible combination of the Vapor-Liquid-Solid (VLS) and oxide assisted (OAG) mechanisms. Figure 15 represents the schematic of the process.

⁹ First characterized in our group by Kevin Luongo, a current PhD student. Later grown in bulk quantities by Eric Huey, current Ph.D. student. Other 1DNS are reviewed in 2.5. Interface/Biomatrix.

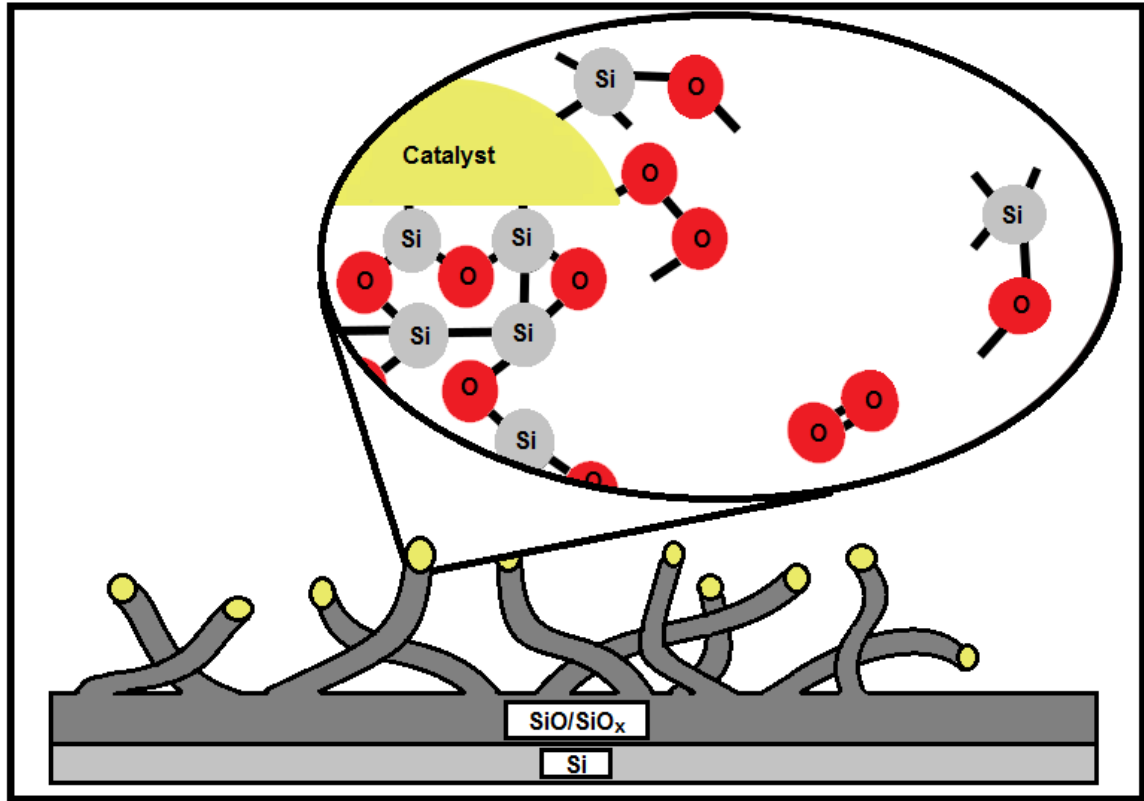

Figure 15 Example of the VLS mechanism for nanowires growing

The VLS and OAG mechanisms are the methods that probably produce the elongated SiO_x nanowires at dry and high temperatures[56]. This theorized mechanism was first discovered by Wagner and Ellis in 1964 [61]. It consists of a continuous melting and solidifying process that produces an elongated SiO_x nanowire forest. At USF after 2 or more hours using Pd as catalysts, the NWs are synthesized. They are later mechanically collected for various purposes.

SiO_x has been previously bound to different biorecognition agents, such as antibodies [62] and enzymes [63]. The USF biomems group have used SiO_x as well on breast cancer cells [64]. These bio affinity properties of SiO_x arise from their feasibility to be easily modified with organosilane compounds. The organosilane compounds serve as a chemical foothold to implement any

biocompatible material [65, 66]. Besides the aforementioned affinity properties, SiO_x has interesting mechanical and optoelectronics properties: the high surface area to volume ratio, increased catalytical activity, mechanical strength, swelling stability, thermal resistance, and fast metal exchange kinetics [67].

3.3. Depositing Nanowires

Electrophoresis (EP) and dielectrophoresis (DEP) are the techniques selected to be used for nanowire deposition. These techniques are easy to implement, affordable, and have been used before for depositing nanostructures [51, 68]. DEP and EP are two related effects created when nanoparticles are moved between electric fields.

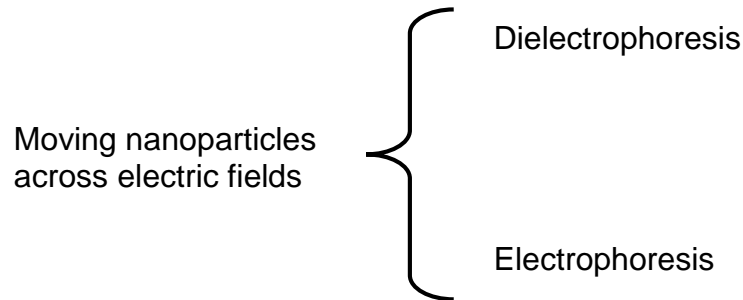

Figure 16 Moving nanoparticles across electric fields

Dielectrophoresis does not need the particle to be charged and can be present in DC or AC conditions. Electrophoresis appears often in DC conditions and requires a charge to be present in particles in order to move them. In both techniques the quality and thickness of the final deposition depend upon type of solvents, electric field strengths, charging salts, time, and distance between electrodes [69]. Table 5 shows a list of parameters used by other researchers for

EP and DEP experiment. Some of these parameters are later taken into account for the DOE in order to determine the most important factors. Figure 17 illustrates the steps for electrophoretal deposition.

Table 5 Sample parameters used for EP and DEP experiments

Reference	Description of the experiment
[70]	CNTs plus Ag SiO ₂ powder (20:30:50).
	Ti mesh -> anode, ITO glass -> cathode, 150 μm separation.
	Dispersion/Solvent: PEI and D184/IPA and Ethanol (3:1).
	Charging salt: (MgNO ₃) ₂ 6H ₂ O, 500 μM.
	35 V constant voltage applied for 210 s.
[71]	Pulsed voltage applied of 35 V with a reverse peak of 0, -1mV, -0.1mV, -3V, paused times of 0.1, 1, 10 100 ms.
	CNTs plus SiO ₂ nanoparticles.
	Stainless steel as both electrodes, 0.01 to 0.02 m separation.
	Solvents: DI Water, Ethanol.
	Surfactants: Triton X-100, PAA, C ₁₆ TMAB, SDS, PVB.
[72]	Constant voltage from 5 to 70 V applied from 60 to 300 s.
	Silica nanoparticles.
	Ti electrodes, 0.02 m separation.
	Solvent: Ethanol and Acetone.
[73]	Constant voltage from 0 to 350 V under 12-24 hr.
	Acid treated CNTs.
	Al electrodes/
	Solvent: DI water.
	AC voltage from 0 to 250 V and 45 Hz to 500 MHz for four hrs.

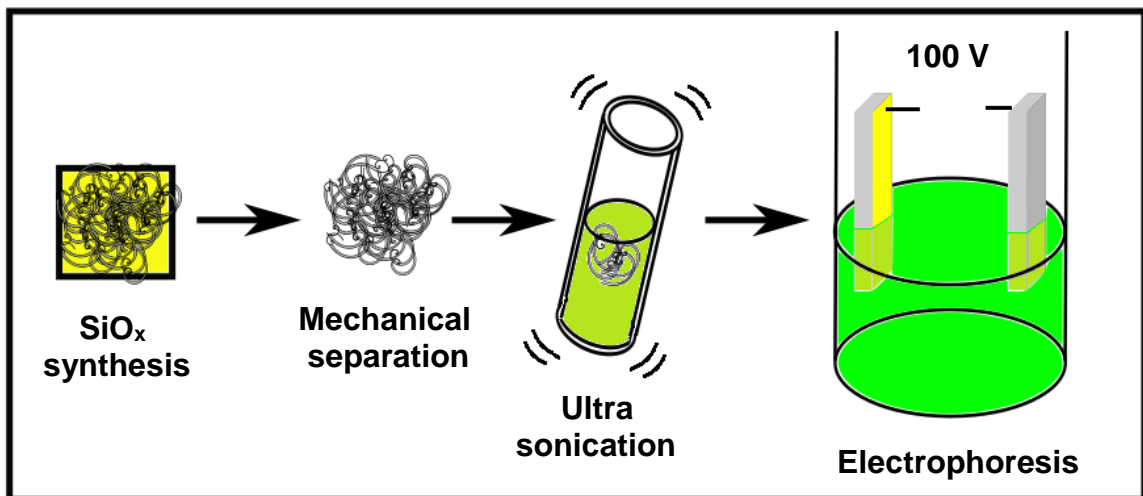

Figure 17 Depositing SiO_x nanowires through electrophoresis

In Figure 17, SiO_x nanowires are first mechanically separated from their metallic growing wafers. In order to confer them a charge, they are mixed with a NiCl₂/D.I. water solution (10 mM). A concentration of 4 mg nanowires and 10 ml NiCl₂ solution is ultrasonicated for mechanical separation purposes. From that concentration, 20 μl of nanowires are dispersed in a closed recipient. A solvent is used (acetonitrile 2ml) for stabilization and suspension effects. The electric field between the 1 cm electrode separation is 100 V. Deposition is done after 1 min, and afterwards they are ambient dried and are ready for protein binding. Figure 18 shows the different deposition densities in the working area achieved under different nanowire volumes, taken from the same NW solution batch.

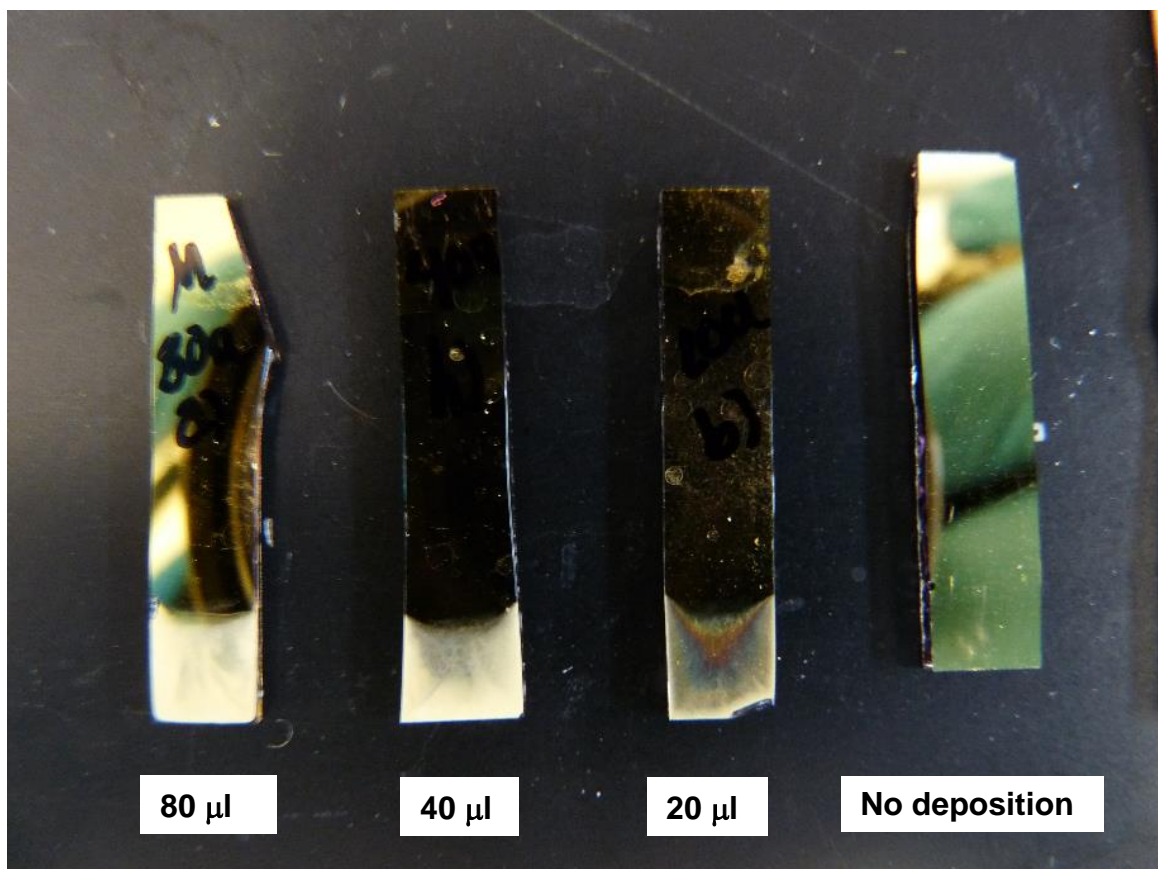

Figure 18 Different volumes of nanowire deposition

3.4. Binding Proteins to SiO_x Nanowires

After depositing the SiO_x nanowires onto the effective area of the working electrode, organosilanes function as molecular bridges to improve bonding between inorganics and organics. It has been shown that they can effectively create good adhesion on SiO₂ surfaces [74]. 3-aminopropyltriethoxysilane (APTES) is a familiar organosilane agent. APTES acts as the interface between the organic and inorganic components in biosensors. APTES has been deeply reviewed [75], and has been used by various researchers for silanization of glass, prior to immobilization of bioagents such as glucose oxidase [76]. Figure 19 describes the silanization process.

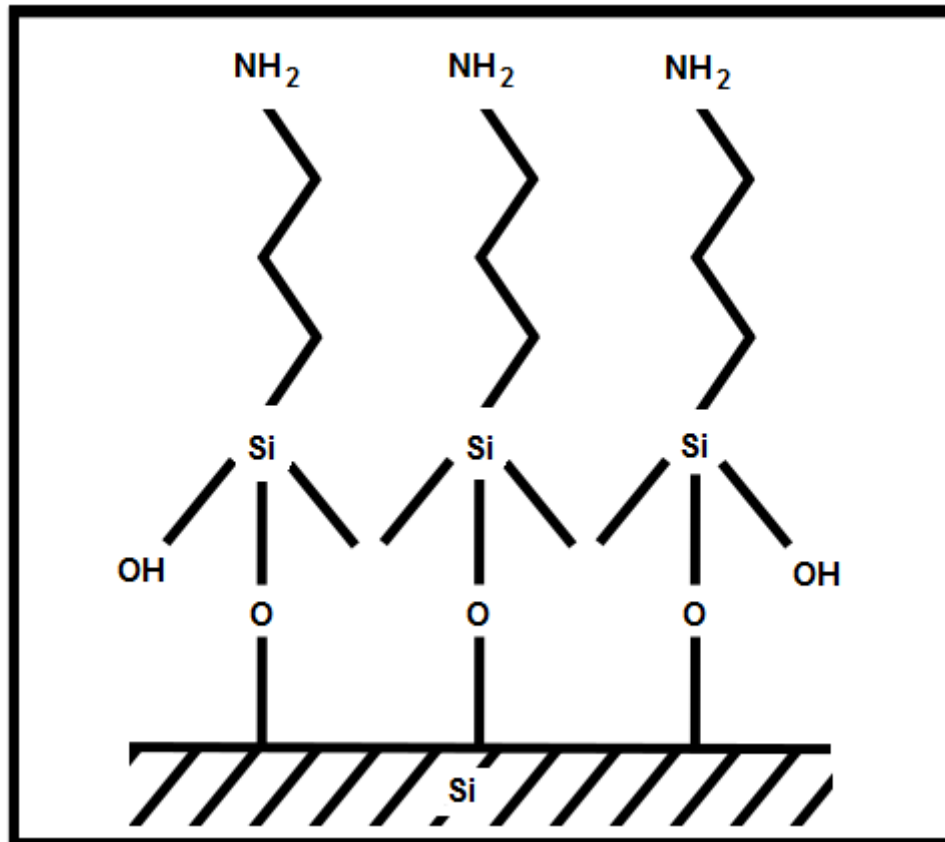

Figure 19 Silanization process

The resulting amino terminated surfaces (NH₂) can be used with crosslinking chemistries in order to attach proteins. Zero-length crosslinkers were used. Their major advantage over other cross linking chemistries is that the bioagent does not require any more chemical linkers to attach to a surface. Zero length cross linkers only activate the protein terminations and leave the final compound, hence their name. As a previous research experiment, 1-ethyl-3-(3-dimethylaminopropyl) carbodiimide (EDC) and N-hydroxysuccinimidyl esters (NHS) were used to attach glucose oxidase to the previously silanized SiO_x nanowires.

EDC and NHS link substances with amines to phosphates, carboxylates, or formyl groups. Since proteins have carboxylate groups at their surfaces, EDC and NHS are a convenient option for covalent binding. The whole reaction between a silanized surface and a protein is depicted in Figure 20 [77].

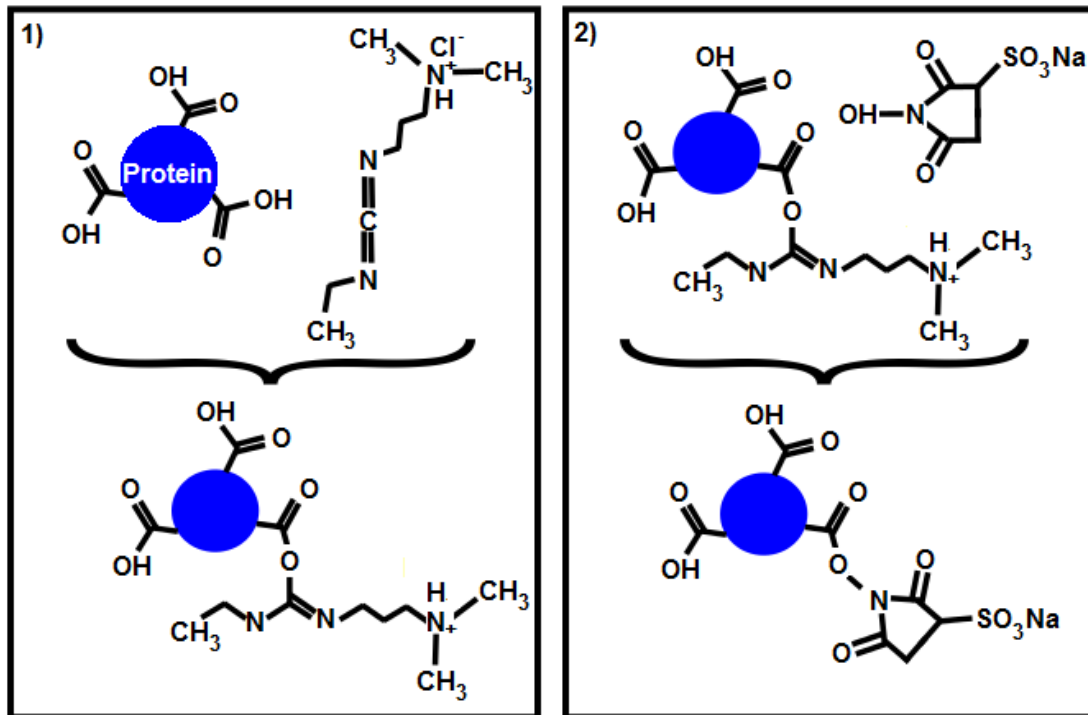

Figure 20 Chemical binding between a silanized surface and a protein

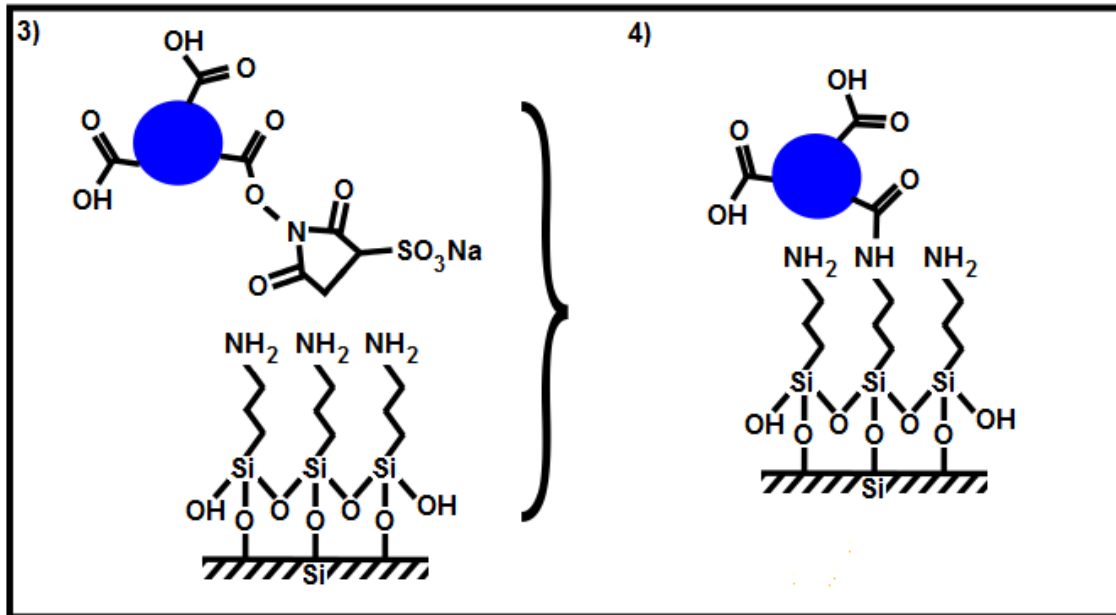

Figure 20 (Continued)

In Figure 20: 1) it shows the reaction between EDC and the protein carboxyl terminations. This reaction leaves highly reactive intermediates, which can later bind with the amine terminations. 2) it shows the Sulfo NHS entering the chemical reaction. This compound is only used to increase solubility and stability, and also creates another intermediate. 3) it shows what happens when the previous chemical intermediate reacts with the amine terminations produced by the APTES silanization. APTES silanization is found in the silanized nanowires. 4) it shows the final reaction between the proteins and the silanized NWs. The Sulfo NHS and the EDC intermediates leave the chemical reaction. This is why they are called zero length cross linkers. As a result, the above chemical reaction scheme produces a covalent binding between enzymes and nanowires. The binding occurs at the support parts of the enzyme leaving the catalytical reaction centers free for electrochemical purposes.

After deposition of SiO_x NWs, they are first silanized by adding APTES (20 μl) on top of them. Silanization occurs at ambient temperature for 2 hours. 2 mg/ml Glucose Oxidase is mixed with EDC (0.4 M) and NHS (0.1 M) in a 7.0 pH Phosphate Based Salt (PBS) buffer (30 μl). Binding occurs again at room temperature for 2 hours. The unbounded enzymes are washed away with PBS buffer [78]. Figure 21 shows the Transmission Electron Microscopy of the bounded proteins to the nanowires.

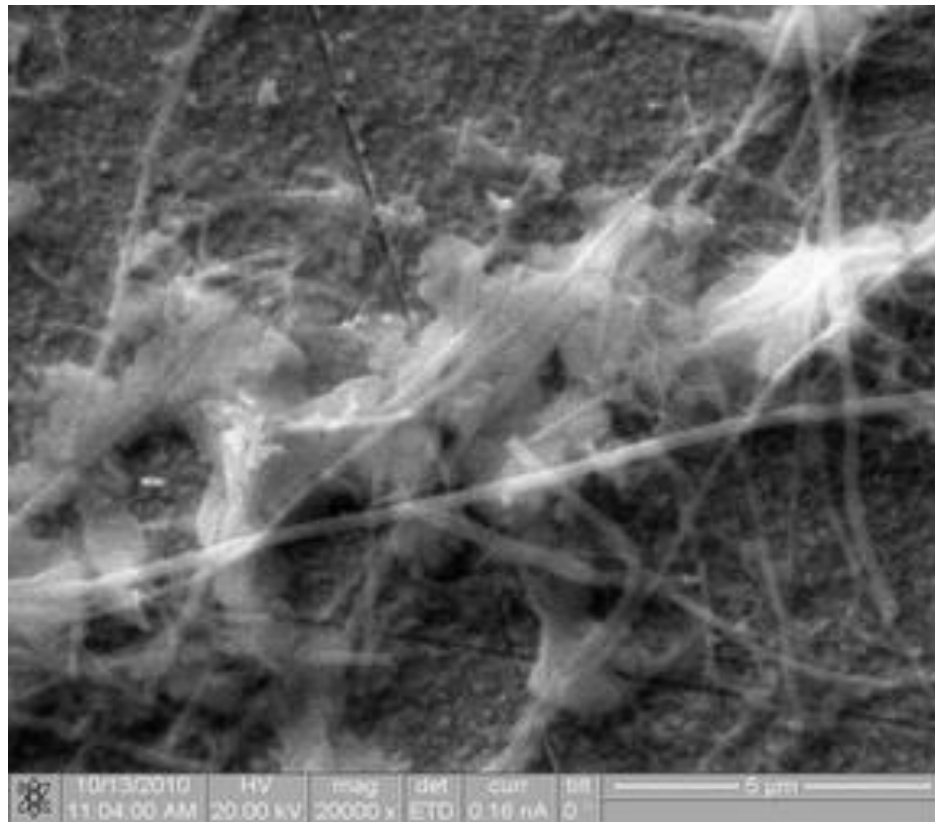

Figure 21 TEM of glucose oxidase and SiO_x nanowires

In the figure above, the globular “jelly” parts are agglomerations of bounded enzymes. It is interesting to notice that these are only getting fused with the nanowires and not the underlying gold surface. This is due to the previous silanization of nanowires.

3.5. Glucose Oxidase (GOx)

For electrochemical experiments, an electro catalytical bioagent is required. The Glucose Oxidase from *Aspergillus Niger* is a well-known and studied electro catalytical enzyme [79]. Glucose oxidase¹⁰, β -D-glucose:oxygen 1-oxidoreductase, or GOD/GOx has two flavin adenine dinucleotides (FAD) acting as the catalytical reaction centers [77, 79-81]. The FADs catalyze the oxidation of D-glucose to D-gluconic acid, as shown in Figure 22 [80].

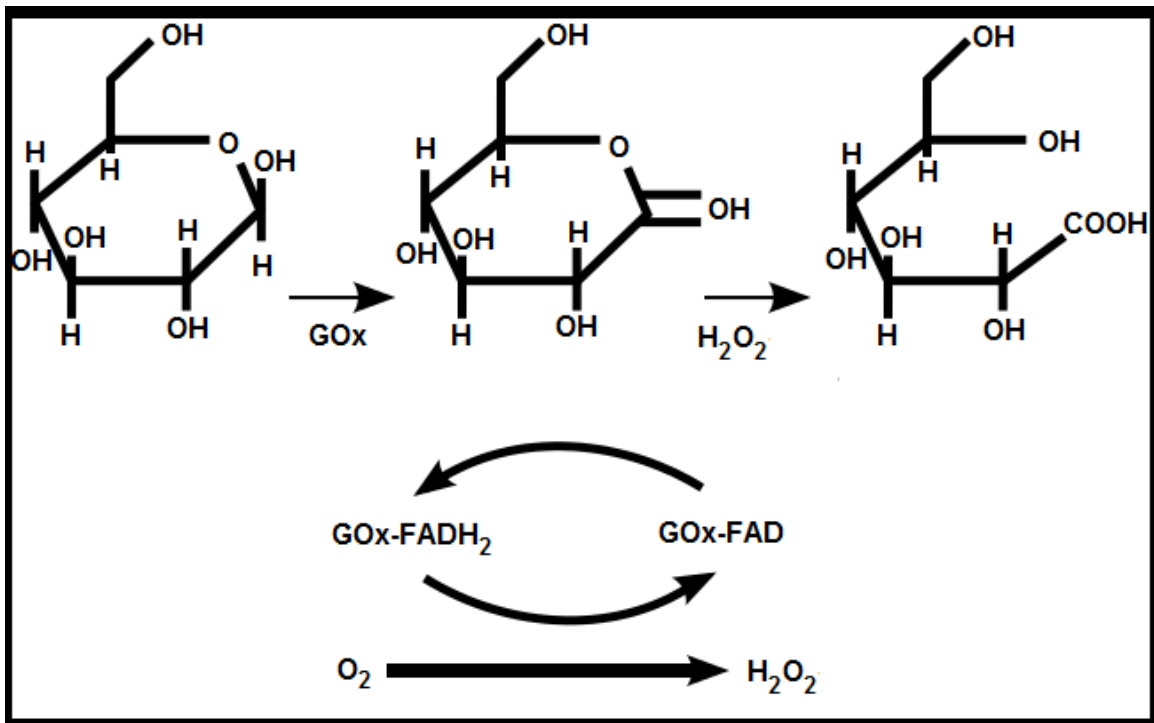

Figure 22 From glucose to gluconic acid

The FADs in glucose oxidase require two half reactions for processing glucose. In the reductive half reaction, GOx catalyzes the oxidation of β -D-glucose

¹⁰ Glucose Oxidase is a dimeric protein. It has an average diameter of 8 nm, a partial specific volume of 0.75 ml/g, a mass of 155±5 K Da (26.56 attograms), an isoelectric point between 3.9 and 4.3, and can work in pHs between 2.0 to 8.0. It is unstable at higher than 40°C [79].

to D-glucono- δ -lactone, which decomposes by reacting with water to form gluconic acid. Inside the enzyme the FAD is reduced to FADH₂. In the oxidative half reaction, the reduced GOx is reoxidized by oxygen to form hydrogen Peroxide (H₂O₂). This reaction is almost instantaneous and GOx keeps on processing glucose until saturation effects.

3.6. DOE Approach

In order to determine which parameter is the most important factor for biosensing sensitivity, the DOE approach analyzes one of the most crucial steps in the biochip construction, the nanowire deposition. The selection on this step process is not trivial. Nanowire synthesis and chemical binding process are also equally relevant. However, the nanowire deposition produces the nanostructures required for the biochip, it is also conferring electrostatic charges on them. All these interesting physical and chemical properties are more easily varied than in the other two important steps. Figure 23 shows the different steps in the bio film creation.

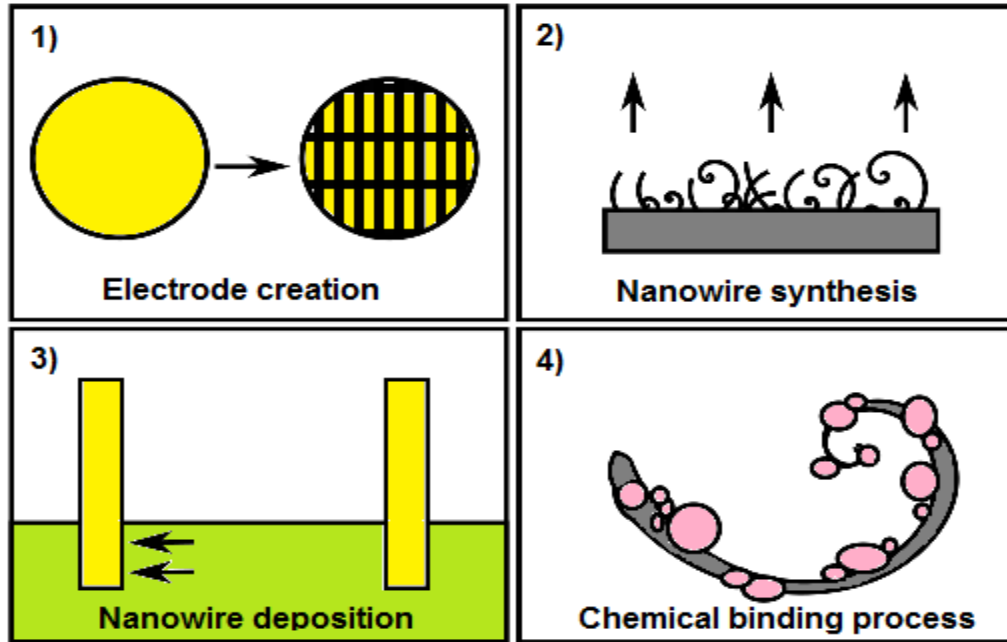

Figure 23 The four basic steps in the biochip creation

To implement the DOE in the specific case of nanowire deposition, a new electrochemical cell is constructed to include the various physical separations between the electrodes. Also salts, time, and voltage sources (AC or DC) are varied under the DOE approach.

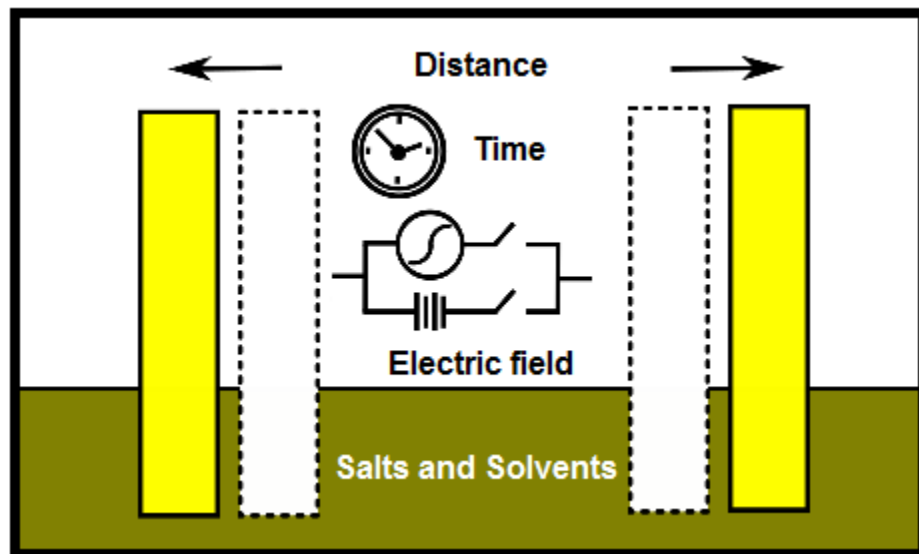

Figure 24 Parameters to be changed in the DOE approach

Chapter 4: Characterization and Experiments

A very important aspect of biosensor construction is the ability to effectively characterize the working areas [82]. In biotechnology some used techniques are: the electron microscopy, RAMAN/Infrared spectroscopy [83, 84], and Atomic Force Microscopy [85]. This study involves the use of Cyclic Voltammetry (CV), which can yield very important information on how the effective area of a biosensor is affected due to some ongoing chemical processes. This chapter also deals with the sensitivity response of the biosensor as well as some of its physical properties. DOE analyzes the most important factors in the nanowire deposition step.

4.1. Cyclic Voltammetry Characterization of the Electrodes

A Potentiostat/Galvanostat from Autolab is used to characterize all the steps in the biochip construction. Sensing, concentration, temperature, and pH studies are also carried out using CV. In all CV studies, except the pH study, a phosphate buffer saline (PBS) buffer (10 mM, pH 7.5) is used. Mediator is a 0.1 mM $\text{Fe}(\text{CN})_6^{3-/4-}$. All experiments are contained in a three electrode cell system having a Ag/AgCl as the reference electrode and Au electrodes as the counter electrodes as depicted in Figure 25.

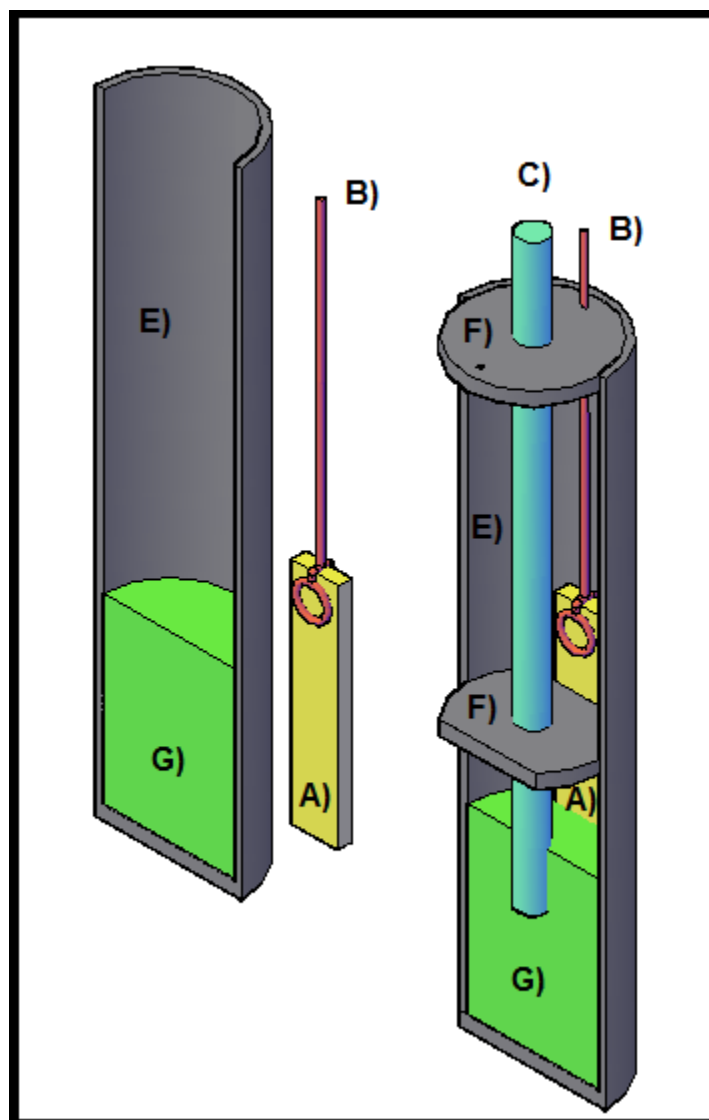

Figure 25 The three electrode cell system

The different components for the three electrode cell system shown in Figure 25 are described next: A) are the gold electrodes; B) is the connection for electrodes/Potentiostat using Cu wires; C) is the reference Ag/AgCl electrode; E) is the containment unit; F) are the retention parts which were modified from plastic test tubes resistant to acetonitrile based solvents and G) is the buffer solution. The counter and working electrodes are used with a separation of 1 cm between them. Au electrodes were suspended and immersed in the liquid media by 0.5 cm.

Kinetic parameters from CV studies often involve complicated electrochemical processes happening near the surrounding working area, and in the electrode itself. For this reason, the CV characterization of the working electrodes gives a general idea of how the surface working area is changing after each chemical or physical modification. The characterization of the electrodes under each different step is presented (all characterization rates go from 10 mV/s to 100 mV/S). These characterization studies of increasing scan rates are important to determine what is happening in the electrochemical process, and will be presented when the Randles-Sevcik equation is introduced.

Results from these characterization studies are presented as follow:

- Characterization of the bare gold electrode, see Figure 26.
- Characterization of the SiO_x NW modified electrode, see Figure 27.
- Characterization of the silanized SiO_x NW modified electrode, see Figure 28.
- Characterization of the Glucose Oxidase conjugated electrode with all the previous modifications, see Figure 29.

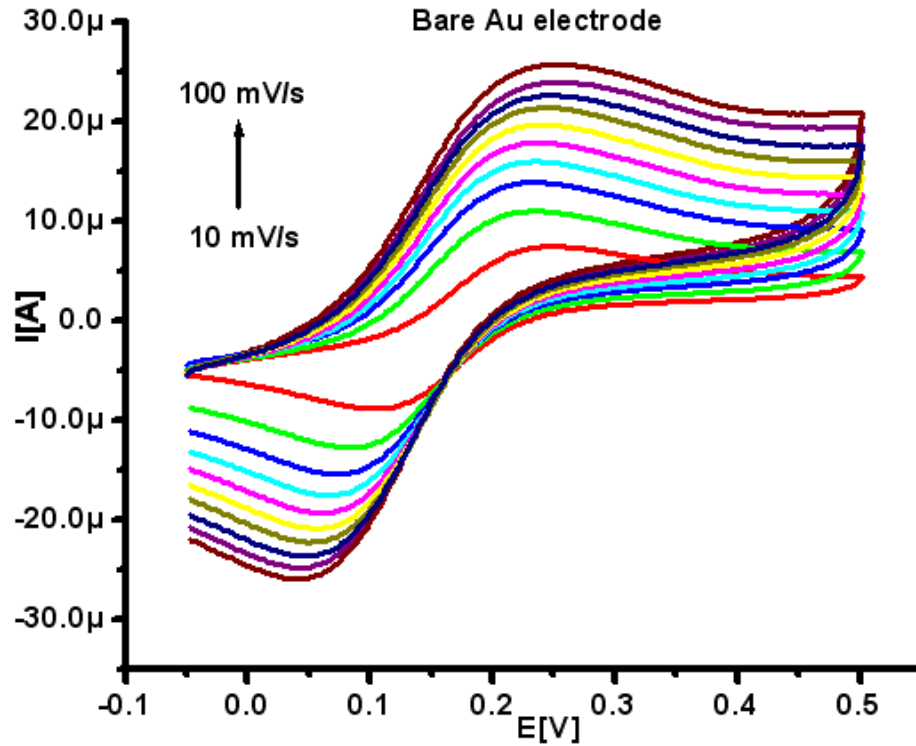

Figure 26 CV characterization of the bare Au electrode

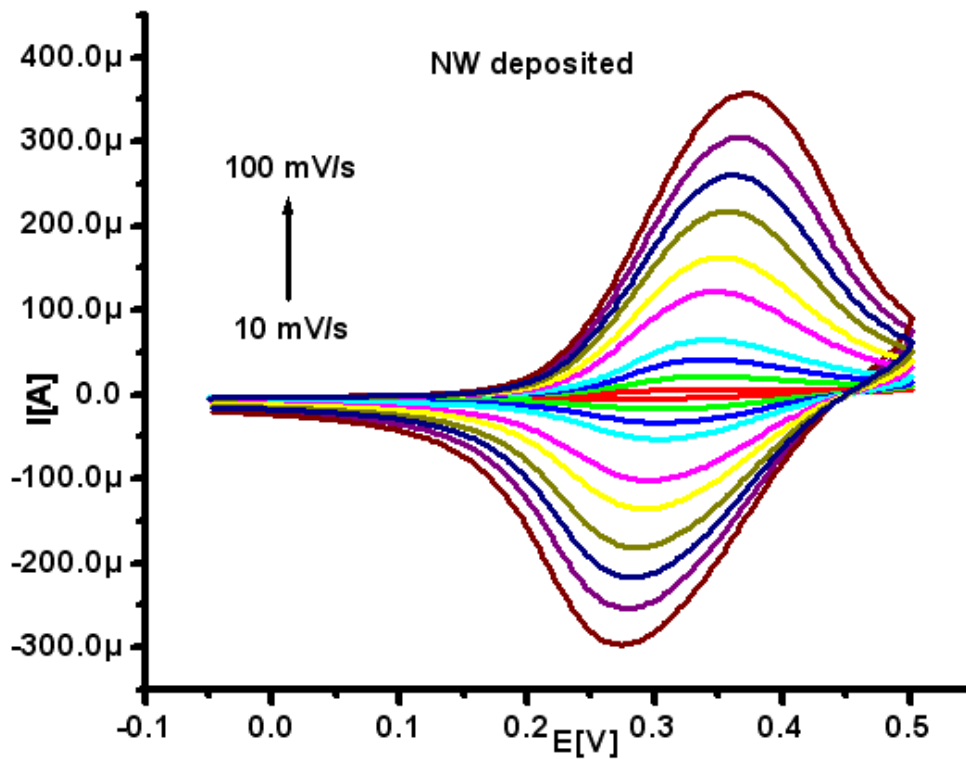

Figure 27 CV of the Au electrode with the NW deposition

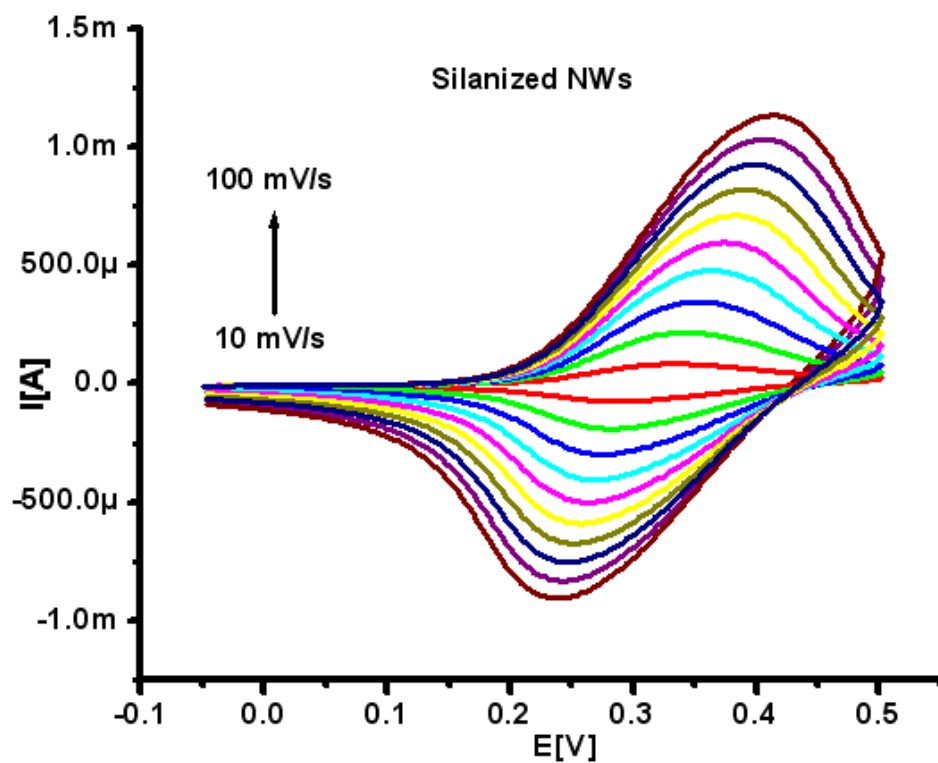

Figure 28 CV of the silanized NW on top of the Au electrode

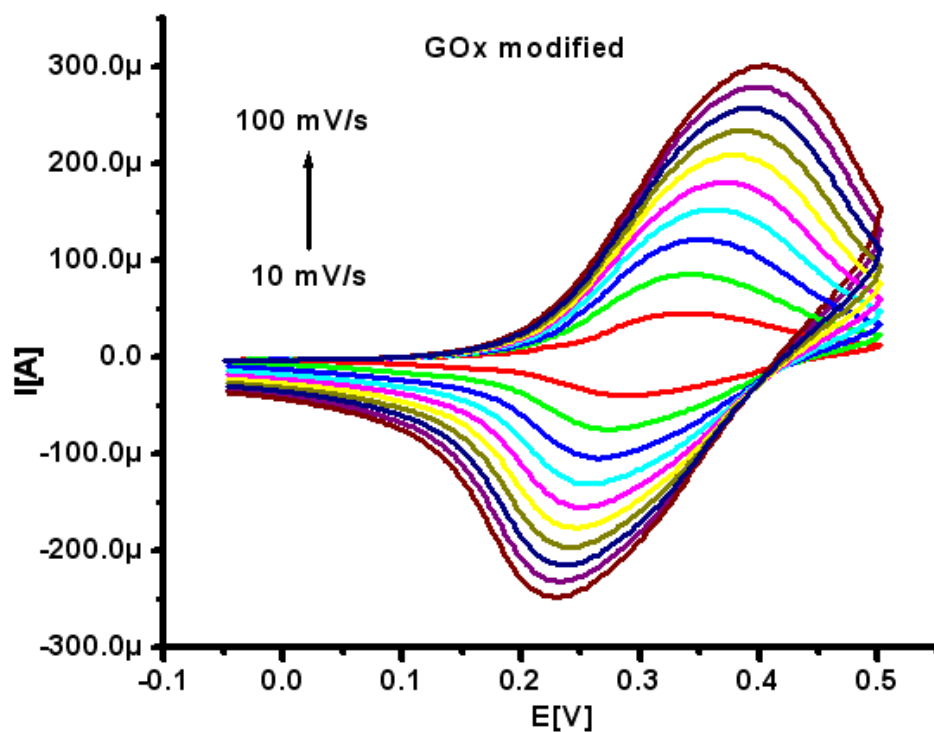

Figure 29 CV of the final modified electrode, glucose oxidase conjugated

The CV curves shown above are dependent on a variety of physicochemical factors. It is important to notice that in all these characterizations the redox species that is being measured is the ferro-ferricyanide couple. The oxidation and reduction peaks of this electro active species are going to be affected by the surface modification happening in the working electrode. Before analyzing the parameters affecting the surface modification it is important to notice that these redox species are being transported from one place to another by a mass transport phenomena.

There are mainly three different mechanisms that can govern mass transport: diffusion, convection and migration. These are briefly described in the following table, adapted from [86].

Table 6 Main governing mass transport phenomena in liquids.

Diffusion	It happens in all solutions and is related to the forces trying to equalize concentration gradients in all liquids.
Convection	Occurs by applying a natural (gravity) or artificial force (mechanical pumps) to induce mixing.
Migration	It implies the attraction of charged species through the use of a certain electric field between electrodes.

Since the electrochemical cell is not moving, it does not have any mechanical pump attached to it, and there is not a significant electric field applied between the electrodes, it is safe to assume that the electrochemical experiment is governed by a diffusion mass transport. The curves also appear to be under a reversible process (the mediator is oxidized, reduced and vice versa). Under these considerations, the magnitude of the peak current is determined by the Randles-Sevcik equation [87].

$$I_p = kn^{3/2}AD^{1/2}C^b\nu^{1/2} \quad (1)$$

Table 7 Factors in the Randle-Sevcik equation

Factor	Description	Units
I_p	Current Peak	A
k	Constant (2.72×10^5)	N/A
n	Number of moles of electrons transferred per mole of electroactive species.	N/A
A	Area of the electrode	cm^2
D	Diffusion coefficient	cm^2/s
C^b	Solution concentration	mol/L
ν	Scan rate	mV/s

In order to more accurately describe what is happening, a new figure comparing the 4 previous results at 50 mV/s is included in Figure 30. The effect of decreasing and increasing the current peaks while all the other factors remain virtually constant, may be due to the increase and reduction of the surface area to volume ratio in the working electrode.

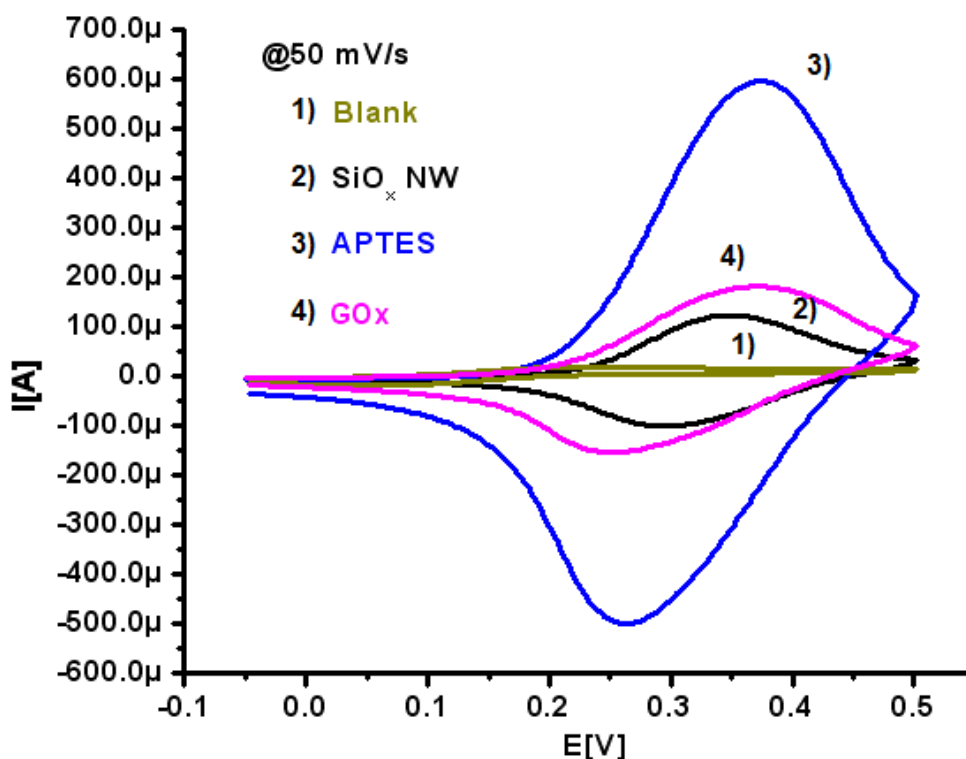

Figure 30 Comparison between the 4 previous results at 50 mV/s

The increase in the oxidation current of the SiO_x/Au on the gold plate 2), compared to that of the Au electrode 1) indicates that the working area surface has been changed with the NWs. This deposition of SiO_x NWs results in the formation of a three dimensional surface electrode with a larger surface area to volume ratio compared to the plain Au surface. Notice that SiO_x NW are dielectric. The increase of the mediator current peaks compared to that of the bare Au electrodes is an interesting phenomenon that it is still yet to be fully explained. It is theorized that the previous chemical modifications (mixing it with the NiCl or Acetonitrile solutions), or perhaps a contamination in the SiO_x NW synthesis process is affecting their electrical conductivity.

The current peak increases at a maximum when the biosensor is APTES modified 3). When the NWs are silanized, the addition of large polarizable amino groups occurs; these amino groups may be positively polarized and can then attract a large number of negatively charged redox species. This theorized effect may facilitate the behavior of the mediator Fe(CN)₆^{3-/4-} and hence the increase in current. When GOx is attached, the current peak shows a decrease in amplitude due to the insulating properties of the molecular structure 4).

4.2. Cyclic Voltammetry Glucose Sensing

For the glucose concentration studies, glucose obtained from Fischer Scientific is diluted into D.I. water. The desired glucose concentrations are mechanically pipetted (20 ul) into the electrochemical cell. This cell contains 2 ml

of the PBS buffer/mediator (0.1 mM) solution. The magnitude of the electrochemical response current of the GOx/APTES/SiO_x NW/Au electrode increases with an increasing concentration of glucose (Figure 31). This can be attributed to the enzymatic catalytic action of GOx which is bound on the silanized SiO_x NW surface.

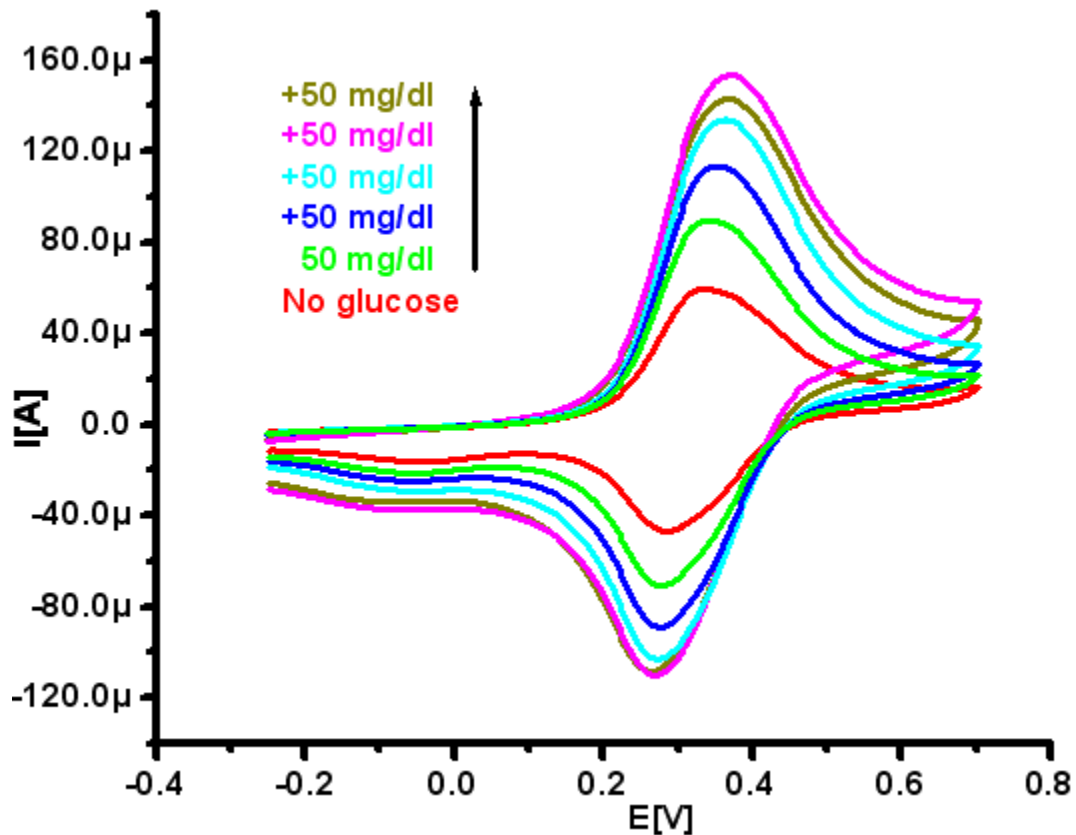

Figure 31 Glucose sensing

It is interesting to notice in Figure 31 that after some glucose additions on the electrochemical cell, the sensor becomes saturated. This is a normal effect on these types of biosensors. This effect can be seen after the 4th glucose addition.

A linear relationship between the magnitude of current and glucose concentration is observed and follows:

$I (\mu\text{A}) = 19.744 (\mu\text{A}) + 0.4359 (\mu\text{A (mg dl}^{-1}\text{)}^{-1}) \text{ glucose concentration (mg dl}^{-1}\text{)}$.
 Notice that the value of the saturated enzyme was not added, because it is assumed that at that point, the enzyme is not properly working anymore. A detection limit of 11 mg dl^{-1} , a standard deviation of $1.60 \mu\text{A}$ and $R^2 = 0.99157$. A high sensitivity of $0.4359 (\mu\text{A (mg dl}^{-1}\text{)}^{-1})$ indicates high loading of GOx on the SiO_x NW (Figure 32).

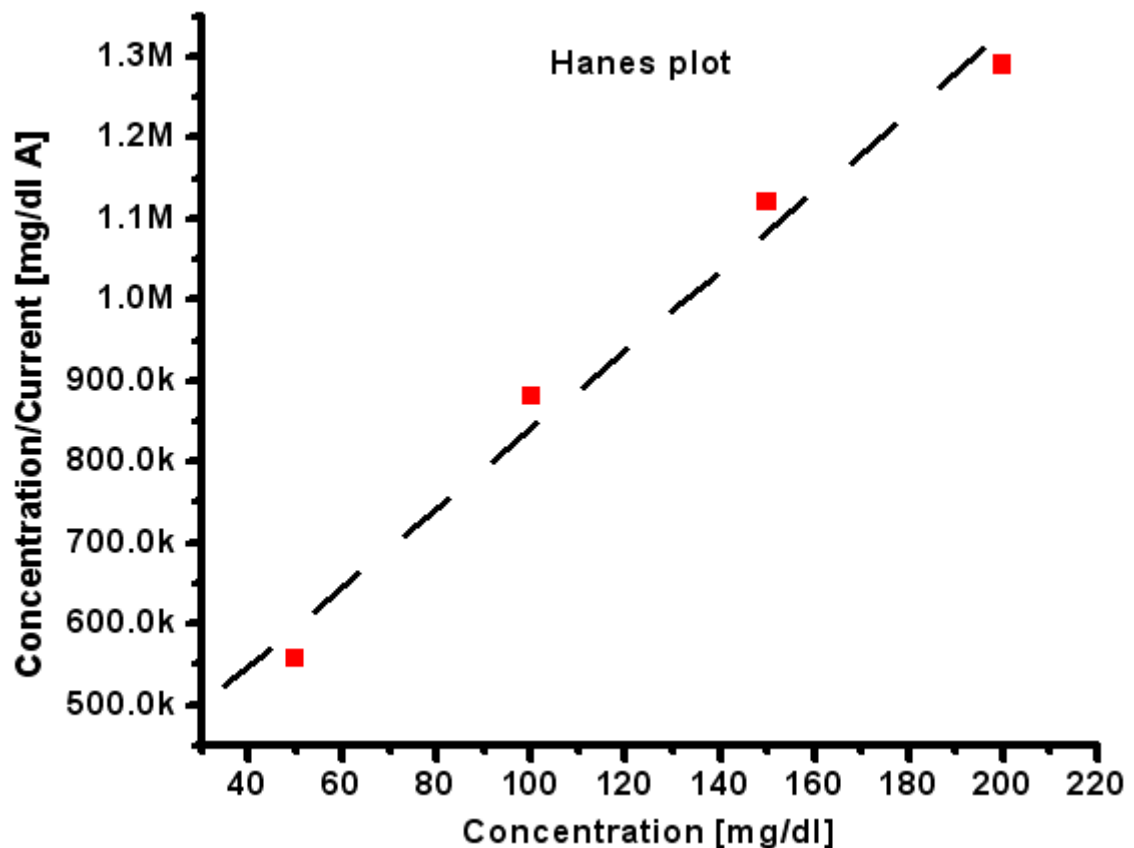

Figure 32 Linear relationship between glucose concentration/detection

4.3. Cyclic Voltammetry Temperature and pH Studies

GOx incurs in denaturation, at temperatures higher than 40°C , although the current peak also increases with rising temperatures. This is only due to

thermodynamic parameters that affect the bioelements as well. For temperature studies, an incubator was used and the electrochemical cell was immersed into it. Temperatures studies ranging between 15°C to 40°C (Figure 33) show a gradually increasing current response for 100 mg dl⁻¹ glucose concentration, revealing a high thermal stability for an immobilized enzyme with a low activation energy (E_a) of 16.56 kJ mol⁻¹ calculated from the Arrhenius plot (Figure 34). Glucose oxidase although highly selective towards glucose, can produce erratic results with other compounds. GOx can function in a pH range from 2.0 to 8.0. Studies from 6.0 to 8.0 pH demonstrate the working capabilities of the biosensor (Figure 35).

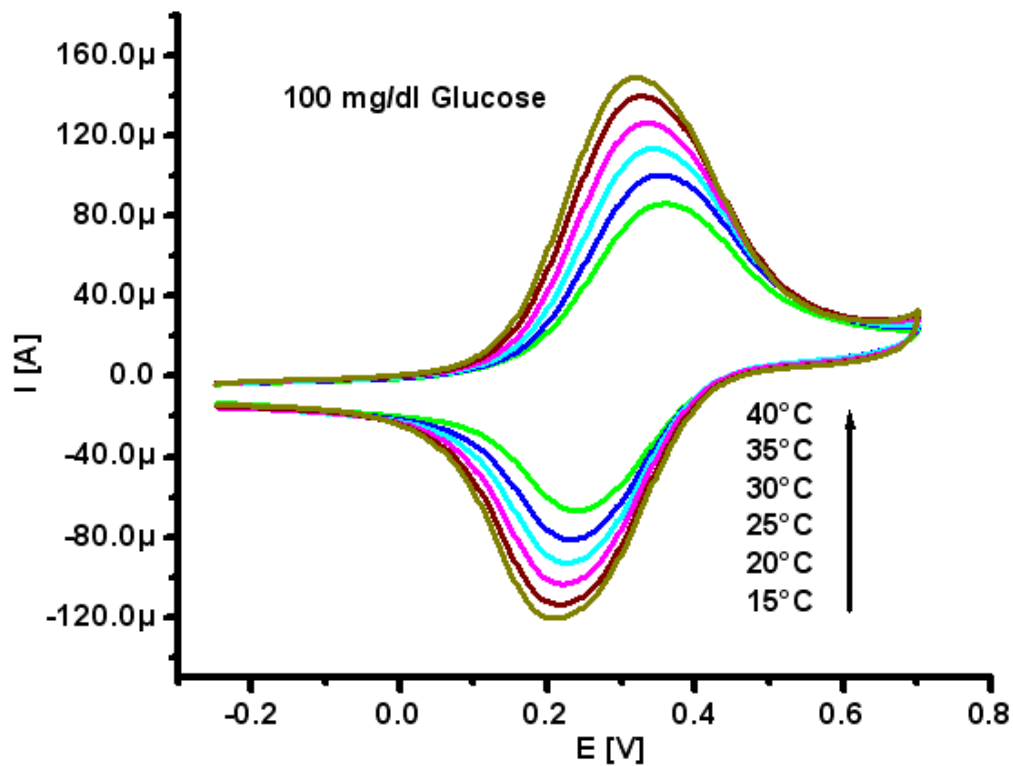

Figure 33 Temperature studies

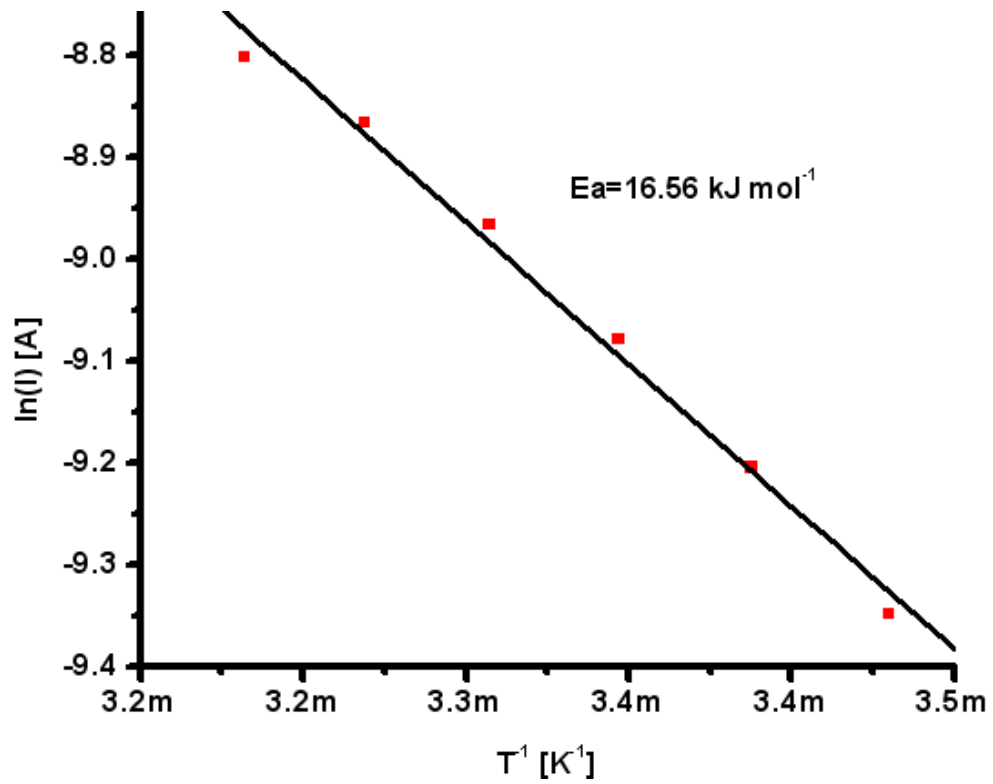

Figure 34 Arrhenius plot

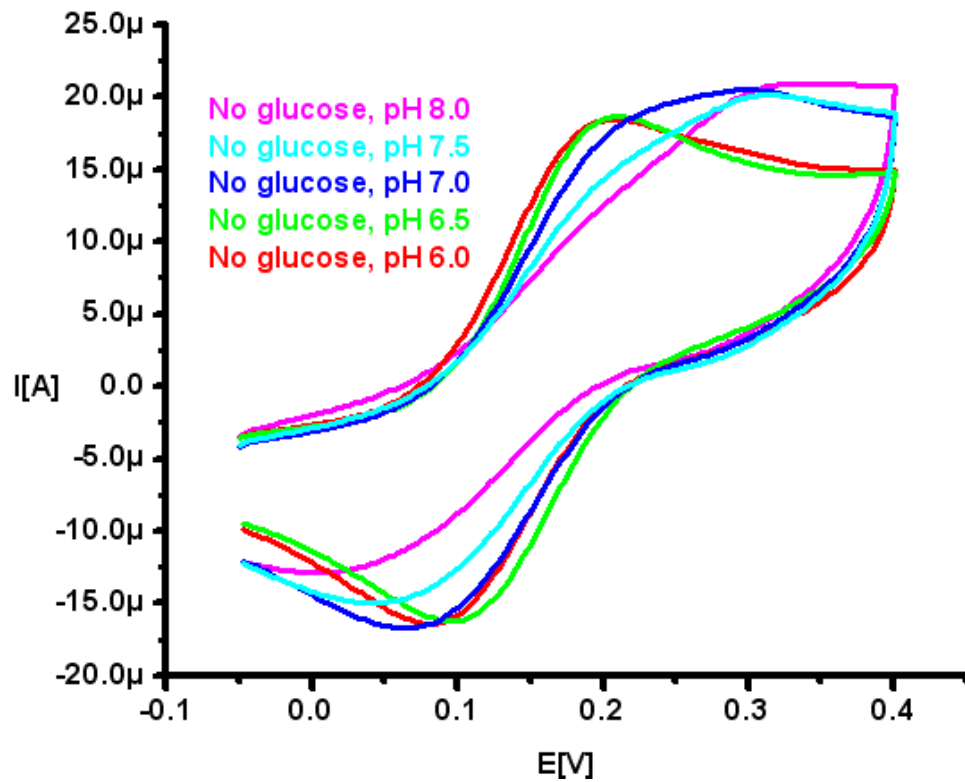

Figure 35 pH studies

4.4. Design of Experiments

From the required factors for electrophoretic or dielectrophoretic deposition reviewed in 3.6. DOE Approach, a 2^6 factorial design is used. Agitation in the solution, shape and size of the containment cell, the electrodes working area, and the temperature of the solution are fixed factors.

Table 8 Factor description for the DOE

Factors	Description/Abbreviation
Time factors	1 min/ T_a 4 min/ T_b
Distance factors	3 mm/ D_a 9mm/ D_b 15 mm/ D_c 21 mm/ D_d
Voltage source factors	AC (50 V) peak to peak/ V_a DC (50 V) / V_b
Solvent factors	Acetonitrile/DI Water/ So_a Acetonitrile 100%/ So_b
Salt factors	NaCl (10 mM)/ Sa_a Mg(NO ₃) ₂ (10 mM)/ Sa_b NiCl (10mM)/ Sa_c MgCl (10mM)/ Sa_d

Table 9 Proposed DOE

Trial	Time factors	Distance factors	Voltage source factors	Solvent factors	Salt factors
1	T_a	D_a	V_b	So_b	Sa_a
2	T_b	D_a	V_b	So_b	Sa_a
3	T_a	D_b	V_b	So_b	Sa_a
4	T_b	D_b	V_b	So_b	Sa_a
5	T_a	D_c	V_b	So_b	Sa_a
6	T_b	D_c	V_b	So_b	Sa_a
7	T_a	D_d	V_b	So_b	Sa_a
8	T_b	D_d	V_b	So_b	Sa_a
9	T_a	D_a	V_a	So_b	Sa_a
10	T_b	D_a	V_a	So_b	Sa_a
11	T_a	D_b	V_a	So_b	Sa_a
12	T_b	D_b	V_a	So_b	Sa_a

Table 9 (Continued)

13	T _a	D _c	V _a	S _{0b}	S _{a_a}
14	T _b	D _c	V _a	S _{0b}	S _{a_a}
15	T _a	D _d	V _a	S _{0b}	S _{a_a}
16	T _b	D _d	V _a	S _{0b}	S _{a_a}
17	T _a	D _a	V _b	S _{0a}	S _{a_a}
18	T _b	D _a	V _b	S _{0a}	S _{a_a}
19	T _a	D _b	V _b	S _{0a}	S _{a_a}
20	T _b	D _b	V _b	S _{0a}	S _{a_a}
21	T _a	D _c	V _b	S _{0a}	S _{a_a}
22	T _b	D _c	V _b	S _{0a}	S _{a_a}
23	T _a	D _d	V _b	S _{0a}	S _{a_a}
24	T _b	D _d	V _b	S _{0a}	S _{a_a}
25	T _a	D _a	V _a	S _{0a}	S _{a_a}
26	T _b	D _a	V _a	S _{0a}	S _{a_a}
27	T _a	D _b	V _a	S _{0a}	S _{a_a}
28	T _b	D _b	V _a	S _{0a}	S _{a_a}
29	T _a	D _c	V _a	S _{0a}	S _{a_a}
30	T _b	D _c	V _a	S _{0a}	S _{a_a}
31	T _a	D _d	V _a	S _{0a}	S _{a_a}
32	T _b	D _d	V _a	S _{0a}	S _{a_a}
33	T _a	D _a	V _b	S _{0b}	S _{a_b}
34	T _b	D _a	V _b	S _{0b}	S _{a_b}
35	T _a	D _b	V _b	S _{0b}	S _{a_b}
36	T _b	D _b	V _b	S _{0b}	S _{a_b}
37	T _a	D _c	V _b	S _{0b}	S _{a_b}
38	T _b	D _c	V _b	S _{0b}	S _{a_b}
39	T _a	D _d	V _b	S _{0b}	S _{a_b}
40	T _b	D _d	V _b	S _{0b}	S _{a_b}
41	T _a	D _a	V _a	S _{0b}	S _{a_b}
42	T _b	D _a	V _a	S _{0b}	S _{a_b}
43	T _a	D _b	V _a	S _{0b}	S _{a_b}
44	T _b	D _b	V _a	S _{0b}	S _{a_b}
45	T _a	D _c	V _a	S _{0b}	S _{a_b}
46	T _b	D _c	V _a	S _{0b}	S _{a_b}
47	T _a	D _d	V _a	S _{0b}	S _{a_b}
48	T _b	D _d	V _a	S _{0b}	S _{a_b}
49	T _a	D _a	V _b	S _{0a}	S _{a_b}
50	T _b	D _a	V _b	S _{0a}	S _{a_b}
51	T _a	D _b	V _b	S _{0a}	S _{a_b}
52	T _b	D _b	V _b	S _{0a}	S _{a_b}
53	T _a	D _c	V _b	S _{0a}	S _{a_b}
54	T _b	D _c	V _b	S _{0a}	S _{a_b}
55	T _a	D _d	V _b	S _{0a}	S _{a_b}
56	T _b	D _d	V _b	S _{0a}	S _{a_b}

Table 9 (Continued)

57	T_a	D_a	V_a	SO_a	S_{ab}
58	T_b	D_a	V_a	SO_a	S_{ab}
59	T_a	D_b	V_a	SO_a	S_{ab}
60	T_b	D_b	V_a	SO_a	S_{ab}
61	T_a	D_c	V_a	SO_a	S_{ab}
62	T_b	D_c	V_a	SO_a	S_{ab}
63	T_a	D_d	V_a	SO_a	S_{ab}
64	T_b	D_d	V_a	SO_a	S_{ab}

A new cell to perform the DOE was constructed and depicted in Figure 36. A subset of the proposed DOE was performed to study nanowire adherence using different salts and leaving all the other parameters fixed.

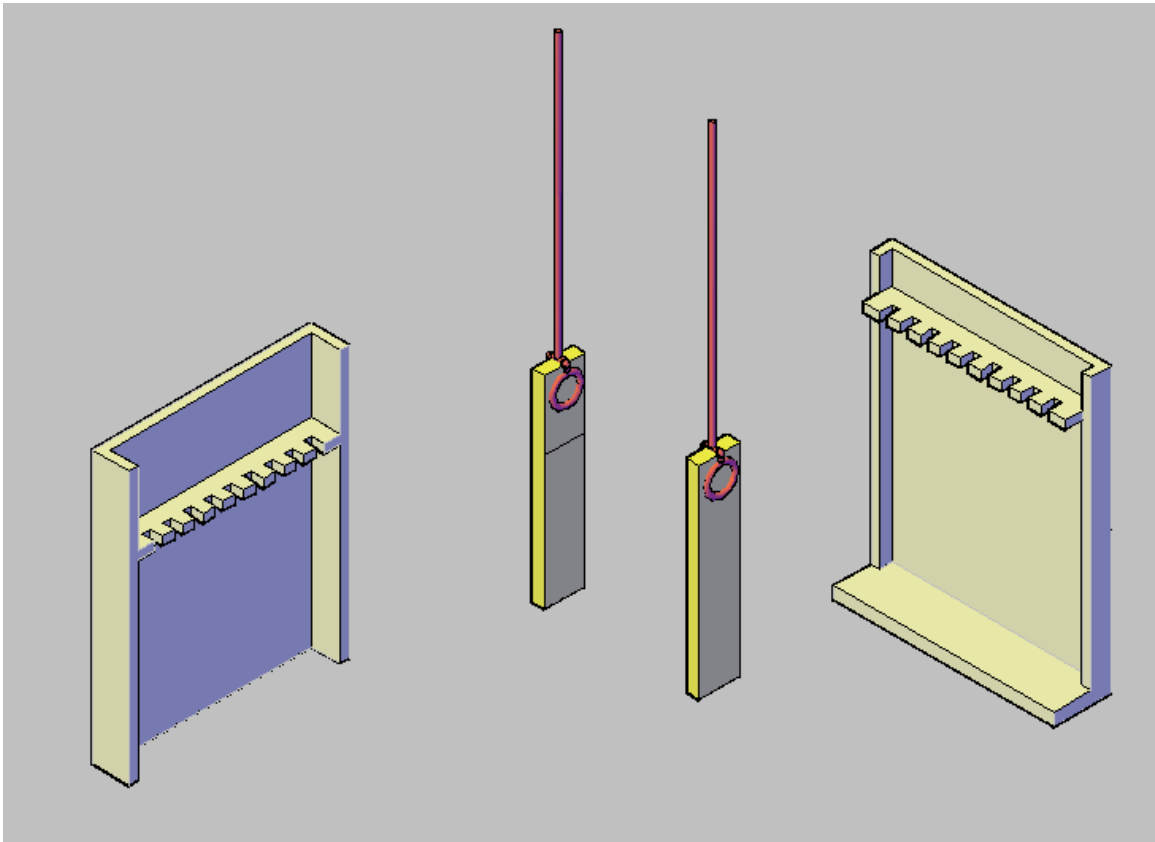

Figure 36 Distance variation in the new cell

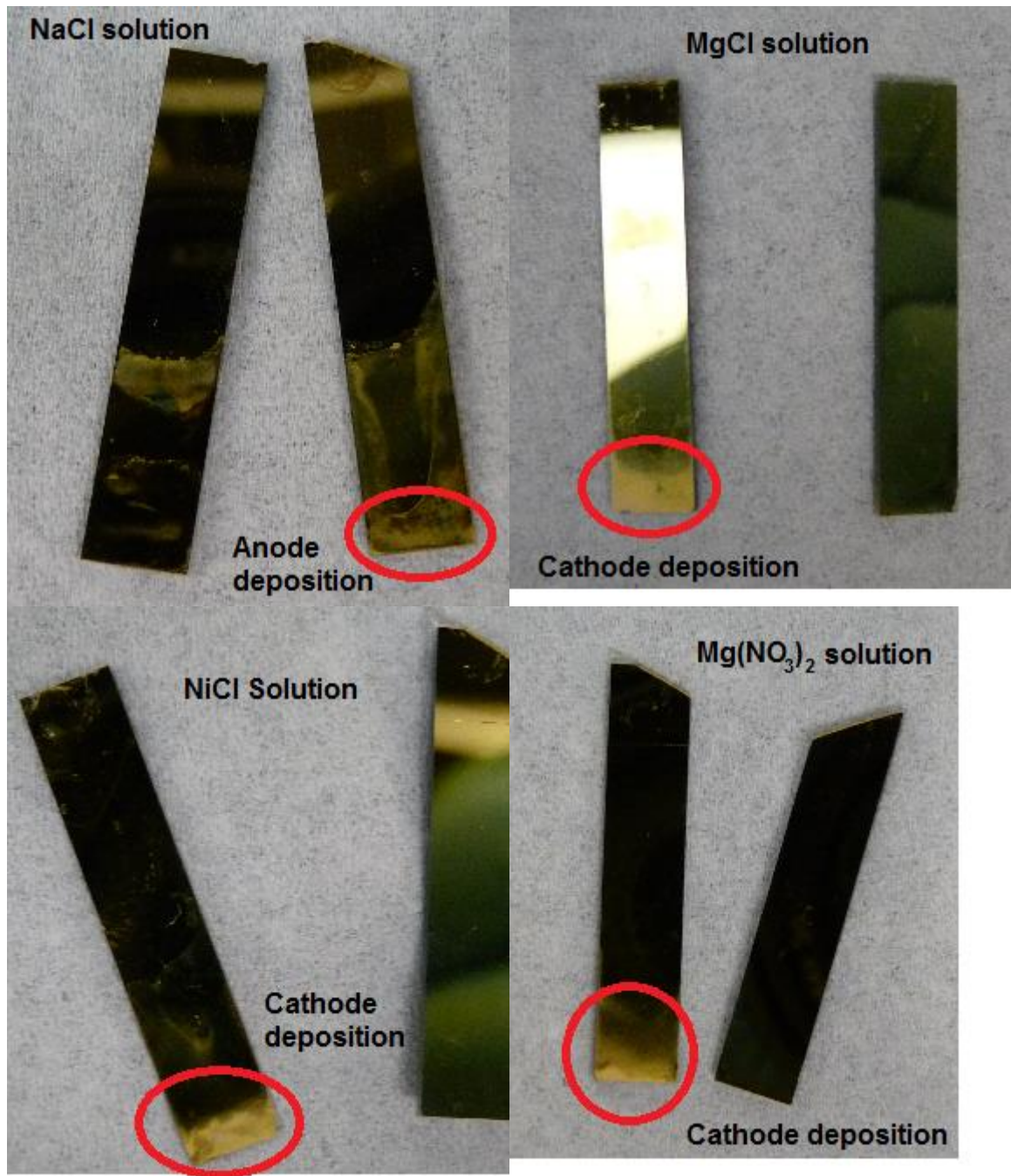

Figure 37 A subset test experiment of the DOE

Figure 37 shows the different depositions using different salts under the following conditions: 4 min deposition, 50 V DC, Acetonitrile solvent, 3 mm separation. It is interesting to note that in the first two solutions, NW deposition

occurs just slightly. When using NiCl or Mg(NO₃)₂, the deposition is more consistent. All these salts are used to induce an electrostatic charge to different nanoparticles [69, 88].

Chapter 5: Conclusions

Electrophoretically deposited Vapor-Liquid-Solid (VLS) grown Silica-W Nanowires on gold electrodes have been used as a suitable biomatrix to covalently immobilize a biorecognition agent, glucose oxidase (GOx). In this dissertation, of a novel glucose biosensor using one-dimensional silicon oxide or silica-w nanowires (SiO_x), with good physical and chemical qualities for interfacing proteins, was successfully designed, fabricated, and tested. To bind the glucose oxidase to the silica-w nanowires, organosilane agents were used such as the 3-aminopropyltriethoxysilane (APTES), and protein termination was activated by the following zero-length crosslinkers: 1-ethyl-3-(3-dimethylaminopropyl) carbodiimide (EDC) and N-hydroxysuccinimidyl esters (NHS), which is known as the EDC-NHS chemistry. The oxide surface layer was first silanized via APTES modification and the carboxyl terminations of GOx was later activated through the EDC/NHS mechanism. This is necessary in order to create a covalent binding between the activated carboxyl terminations of the protein and the amino terminations on the NWs.

Cyclic voltammetry (CV) techniques were used to characterize the different modified surfaces that were produced on the biosensor construction steps. An interesting comparison between the scan rates of the electrodes with NW

deposition and those of bare Au electrodes, shows an increased current ion flux in the NW modified electrodes.

CV was also used to determine the presence of glucose in a PBS buffer using ferri/ferrocyanide ($\text{Fe}[\text{CN}]_6^{3-/4-}$) mediator. The response characteristics of the glucose bioelectrode were: linearity: 25-300 mg dl⁻¹, detection limit: 11 mg dl⁻¹, sensitivity: 0.463 μA (mg dl⁻¹)⁻¹, along with thermal and pH stability. A subset of the performed DOE showed the importance of the correct selection of charge inducing salts. For the deposition of NWs, salt selection was a key factor in the biosensor construction.

5.1 Future Work

The optimum deposition of the NWs remains a challenge. Improving the NWs conformity will have a direct effect on the accuracy and consistency of the response among different biosensor devices. When the NWs are deposited there are variations in the lengths and diameters of the NWs which affect the sensor response. This challenge can be overcome by using the following ideas:

- Finding the optimum set of factors by completing the proposed DOE. It has been published in the literature that nanostructures can be slightly manipulated through electrophoresis (EP) or dielectrophoresis (DEP) in order to improve surface conformation. The proposed DOE designed in this dissertation takes into account some of the most influential factors that affect NW deposition including the application of different electric fields.

- Nanowires can be normalized by chemical or physical modifications after ultrasonication separation. For example, Carbon nanotubes can be attacked with acids and even ball milled to obtain a better consistency on their length sizes [73]. Normalization is necessary because SiO_x NW are usually harvested from nanowire forests having huge differences in their size and lengths. Research findings has shown that sometimes NWs can reach even 280 μm in length [56]. After NW normalization, NWs can be used in a modified electrophoretic or dielectrophoretic cell and later be deposited after crossing a filter layer. This scheme is very closely related to the electro migration procedure used in biomolecular techniques where agarose gel filters are used.

References

1. Balasubramanian, K., *Challenges in the use of 1D nanostructures for on-chip biosensing and diagnostics: A review*. Biosensors & Bioelectronics, 2010. **26**(4): p. 1195-1204.
2. Patolsky, F., G. Zheng, and C.M. Lieber, *Nanowire sensors for medicine and the life sciences*. Nanomedicine, 2006. **1**(1): p. 51-65.
3. Liu, A.H., *Towards development of chemosensors and biosensors with metal-oxide-based nanowires or nanotubes*. Biosensors & Bioelectronics, 2008. **24**(2): p. 167-177.
4. Virkler, K. and I.K. Lednev, *Analysis of body fluids for forensic purposes: From laboratory testing to non-destructive rapid confirmatory identification at a crime scene*. Forensic Science International, 2009. **188**(1-3): p. 1-17.
5. Amine, A., et al., *Enzyme inhibition-based biosensors for food safety and environmental monitoring*. Biosensors & Bioelectronics, 2006. **21**(8): p. 1405-1423.
6. Paddle, B.M., *Biosensors for chemical and biological agents of defence interest*. Biosensors & Bioelectronics, 1996. **11**(11): p. 1079-1113.
7. Singh, S., *Sensors - An effective approach for the detection of explosives*. Journal of Hazardous Materials, 2007. **144**(1-2): p. 15-28.
8. Malhotra, B.D. and A. Chaubey, *Biosensors for clinical diagnostics industry*. Sensors and Actuators B-Chemical, 2003. **91**(1-3): p. 117-127.
9. Sadana, A.S.N., *Handbook of Biosensors and Biosensors Kinetics*. First edition ed. 2011: Elsevier.
10. Asuri, P., et al., *The protein-nanomaterial interface*. Current Opinion in Biotechnology, 2006. **17**(6): p. 562-568.
11. Roach, P., et al., *Modern biomaterials: a review-bulk properties and implications of surface modifications*. Journal of Materials Science-Materials in Medicine, 2007. **18**(7): p. 1263-1277.

12. Fournier-Wirth, C. and J. Coste, *Nanotechnologies for pathogen detection: Future alternatives?* Biologicals, 2010. **38**(1): p. 9-13.
13. Roco, M.C., *Nanotechnology: convergence with modern biology and medicine.* Current Opinion in Biotechnology, 2003. **14**(3): p. 337-346.
14. Kuchibhatla, S., et al., *One dimensional nanostructured materials.* Progress in Materials Science, 2007. **52**(5): p. 699-913.
15. Xu, X., et al., *Integration of electrochemistry in micro-total analysis systems for biochemical assays: Recent developments.* Talanta, 2009. **80**(1): p. 8-18.
16. Lavrik, N.V., M.J. Sepaniak, and P.G. Datskos, *Cantilever transducers as a platform for chemical and biological sensors.* Review of Scientific Instruments, 2004. **75**(7): p. 2229-2253.
17. Hennion, M.C. and D. Barcelo, *Strengths and limitations of immunoassays for effective and efficient use for pesticide analysis in water samples: A review.* Analytica Chimica Acta, 1998. **362**(1): p. 3-34.
18. Kohler, G. and C. Milstein, *Continuous cultures of fused cells secreting antibody of predefined specificity (Reprinted from Nature, vol 256, 1975).* Journal of Immunology, 2005. **174**(5): p. 2453-2455.
19. Hoogenboom, H.R., et al., *Antibody phage display technology and its applications.* Immunotechnology, 1998. **4**(1): p. 1-20.
20. Tombelli, S., A. Minunni, and A. Mascini, *Analytical applications of aptamers.* Biosensors & Bioelectronics, 2005. **20**(12): p. 2424-2434.
21. Meloni, R., O. Khalfallah, and N.F. Biguet, *DNA microarrays and pharmacogenomics.* Pharmacological Research, 2004. **49**(4): p. 303-308.
22. Song, S.P., et al., *Aptamer-based biosensors.* Trac-Trends in Analytical Chemistry, 2008. **27**(2): p. 108-117.
23. Cornish-Bowden, A., *History of Enzyme Chemistry*, in eLS. 2001, John Wiley & Sons, Ltd.
24. van Beilen, J.B. and Z. Li, *Enzyme technology: an overview.* Current Opinion in Biotechnology, 2002. **13**(4): p. 338-344.
25. Sze, K.L. and B.N. Tzi, *Lectins: production and practical applications.* Applied Microbiology and Biotechnology, 2011. **89**(1): p. 45-55.

26. Jelinek, R. and S. Kolusheva, *Carbohydrate biosensors*. Chemical Reviews, 2004. **104**(12): p. 5987-6015.
27. Banerjee, P. and A.K. Bhunia, *Mammalian cell-based biosensors for pathogens and toxins*. Trends in Biotechnology, 2009. **27**(3): p. 179-188.
28. Beloqui, A., et al., *Recent trends in industrial microbiology*. Current Opinion in Microbiology, 2008. **11**(3): p. 240-248.
29. Rosche, B., et al., *Microbial biofilms: a concept for industrial catalysis?* Trends in Biotechnology, 2009. **27**(11): p. 636-643.
30. Tiwari, J.N., R.N. Tiwari, and K.S. Kim, *Zero-dimensional, one-dimensional, two-dimensional and three-dimensional nanostructured materials for advanced electrochemical energy devices*. Progress in Materials Science, 2012. **57**(4): p. 724-803.
31. Pokropivny, V.V. and V.V. Skorokhod, *New dimensionality classifications of nanostructures*. Physica E-Low-Dimensional Systems & Nanostructures, 2008. **40**(7): p. 2521-2525.
32. Byers, R.J. and E.R. Hitchman, *Quantum Dots Brighten Biological Imaging*. Progress in Histochemistry and Cytochemistry, 2011. **45**(4): p. 201-237.
33. Xu, B.-s., *Prospects and research progress in nano onion-like fullerenes*. New Carbon Materials, 2008. **23**(4): p. 289-301.
34. Mandal, S., S. Phadtare, and M. Sastry, *Interfacing biology with nanoparticles*. Current Applied Physics, 2005. **5**(2): p. 118-127.
35. Shankar, K.S. and A.K. Raychaudhuri, *Fabrication of nanowires of multicomponent oxides: Review of recent advances*. Materials Science & Engineering C-Biomimetic and Supramolecular Systems, 2005. **25**(5-8): p. 738-751.
36. Perez-Juste, J., et al., *Gold nanorods: Synthesis, characterization and applications*. Coordination Chemistry Reviews, 2005. **249**(17-18): p. 1870-1901.
37. Pagona, G. and N. Tagmatarchis, *Carbon nanotubes: Materials for medicinal chemistry and biotechnological applications*. Current Medicinal Chemistry, 2006. **13**(15): p. 1789-1798.
38. Pan, Z.W., Z.R. Dai, and Z.L. Wang, *Nanobelts of semiconducting oxides*. Science, 2001. **291**(5510): p. 1947-1949.

39. Cai, J., et al., *Atomically precise bottom-up fabrication of graphene nanoribbons*. Nature, 2010. **466**(7305): p. 470-473.
40. Gruetzmacher, D., et al., *Ultra flexible SiGe/Si/Cr nanosprings*. Microelectronics Journal, 2008. **39**(3-4): p. 478-481.
41. Ma, W. and X. Zhang, *Study of the thermal, electrical and thermoelectric properties of metallic nanofilms*. International Journal of Heat and Mass Transfer. **58**(1&2): p. 639-651.
42. Wu, Y.H., T. Yu, and Z.X. Shen, *Two-dimensional carbon nanostructures: Fundamental properties, synthesis, characterization, and potential applications*. Journal of Applied Physics, 2010. **108**(7).
43. Ghosh, S. and P.S. Mukherjee, *Self-assembly of molecular nanoball: Design, synthesis, and characterization*. Journal of Organic Chemistry, 2006. **71**(22): p. 8412-8416.
44. Swain, B.S., et al., *Transformation of silicon nanowires to nanocoils by annealing in reducing atmosphere*. Journal of Crystal Growth, 2011. **327**(1): p. 276-280.
45. Brinkmann, G. and N. Van Cleemput, *Classification and generation of nanocones*. Discrete Applied Mathematics, 2011. **159**(15): p. 1528-1539.
46. Du, J.M., et al., *Carbon nanoflowers synthesized by a reduction-pyrolysis-catalysis route*. Materials Letters, 2005. **59**(4): p. 456-458.
47. Chen, Q. and N.M. Pugno, *In-plane elastic properties of hierarchical nano-honeycombs: The role of the surface effect*. European Journal of Mechanics a-Solids, 2013. **37**: p. 248-255.
48. Monthieux, M. and V.L. Kuznetsov, *Who should be given the credit for the discovery of carbon nanotubes?* Carbon, 2006. **44**(9): p. 1621-1623.
49. Solanki, P.R., et al., *Nanostructured metal oxide-based biosensors*. NPG Asia Materials, 2011. **3**(1): p. 17-24.
50. Kadaksham, J., P. Singh, and N. Aubry, *Manipulation of particles using dielectrophoresis*. Mechanics Research Communications, 2006. **33**(1): p. 108-122.
51. Boccaccini, A.R., et al., *The electrophoretic deposition of inorganic nanoscaled materials*. Journal of the Ceramic Society of Japan, 2006. **114**(1325): p. 1-14.

52. Zhang, S., G. Wright, and Y. Yang, *Materials and techniques for electrochemical biosensor design and construction*. Biosensors & Bioelectronics, 2000. **15**(5-6): p. 273-282.
53. Cao, L.Q., *Immobilised enzymes: science or art?* Current Opinion in Chemical Biology, 2005. **9**(2): p. 217-226.
54. Star, A., et al., *Electronic detection of specific protein binding using nanotube FET devices*. Nano Letters, 2003. **3**(4): p. 459-463.
55. Habermuller, L., M. Mosbach, and W. Schuhmann, *Electron-transfer mechanisms in amperometric biosensors*. Fresenius Journal of Analytical Chemistry, 2000. **366**(6-7): p. 560-568.
56. Shalav, A., T. Kim, and R.G. Elliman, *SiO(x) Nanowires Grown via the Active Oxidation of Silicon*. Ieee Journal of Selected Topics in Quantum Electronics, 2011. **17**(4): p. 785-793.
57. Cheong, K.Y. and Y.L. Chiew, eds. *Advances of SiOx and Si/SiOx Core-Shell Nanowires*. Nanowires Science and Technology, ed. N. Lupu. 2010, INTECH: Croatia. 131-150.
58. Schmidt, V., et al., *Silicon Nanowires: A Review on Aspects of their Growth and their Electrical Properties*. Advanced Materials, 2009. **21**(25-26): p. 2681-2702.
59. Sekhar, P.K., et al., *Selective growth of silica nanowires in silicon catalysed by Pt thin film*. Nanotechnology, 2006. **17**(18): p. 4606-4613.
60. Sekhar, P.K. and S. Bhansali, *Manufacturing aspects of oxide nanowires*. Materials Letters, 2010. **64**(6): p. 729-732.
61. Wagner, R.S. and W.C. Ellis, *VAPOR-LIQUID-SOLID MECHANISM OF SINGLE CRYSTAL GROWTH (NEW METHOD GROWTH CATALYSIS FROM IMPURITY WHISKER EPITAXIAL + LARGE CRYSTALS SI E)*. Applied Physics Letters, 1964. **4**(5): p. 89-&.
62. Lee, S.B., et al., *Antibody-based bio-nanotube membranes for enantiomeric drug separations*. Science, 2002. **296**(5576): p. 2198-2200.
63. Zhou, G., et al., *Immobilization of glucose oxidase on rod-like and vesicle-like mesoporous silica for enhancing current responses of glucose biosensors*. Talanta. **In Press, Accepted Manuscript**.
64. Alexander Jr, F., et al., *Quantitative impedance analysis of nanowires and cancer cells*. Procedia Engineering. **5**: p. 842-845.

65. Dey, R.K., et al., *Attachment of linear poly(amido amine) to silica surface and evaluation of metal-binding behavior*. Applied Surface Science, 2009. **255**(18): p. 8176-8182.
66. Achatz, D.E., et al., *Colloidal silica nanoparticles for use in click chemistry-based conjugations and fluorescent affinity assays*. Sensors and Actuators B-Chemical, 2010. **150**(1): p. 211-219.
67. Sreedhar, B., et al., *Regioselective ring opening of epoxides with amines using monodispersed silica nanoparticles in water*. Journal of Molecular Catalysis a-Chemical, 2007. **272**(1-2): p. 159-163.
68. Rajaraman, S., et al., *Rapid, low cost microfabrication technologies toward realization of devices for dielectrophoretic manipulation of particles and nanowires*. Sensors and Actuators B-Chemical, 2006. **114**(1).
69. Boccaccini, A.R., et al., *Electrophoretic deposition of carbon nanotubes*. Carbon, 2006. **44**(15): p. 3149-3160.
70. Wang, S.-C. and B.-C. Huang, *Field emission properties of Ag/SiO₂/carbon nanotube films by pulsed voltage co-electrophoretic deposition*. Thin Solid Films, 2008. **517**(3): p. 1245-1250.
71. Chicatun, F., et al., *Carbon nanotube deposits and CNT/SiO₂ composite coatings by electrophoretic deposition*. Advances in Applied Ceramics, 2007. **106**(4): p. 186-195.
72. Tomasi, R., et al., *Preparation of a thermal insulating material using electrophoretic deposition of silica particles*. Materials Science and Engineering B-Solid State Materials for Advanced Technology, 2007. **137**(1-3): p. 225-231.
73. Chan, Z., et al., *Influence of AC electric field on dispersion of carbon nanotubes in liquids*. Journal of Dispersion Science and Technology, 2006. **27**(7): p. 935-940.
74. Petrie, E.M., *Silanes as Primers and Adhesion Promoters for Metal Substrates*. Metal Finishing. **105**(7-8): p. 85-93.
75. Vandenberg, E.T., et al., *STRUCTURE OF 3-AMINOPROPYL TRIETHOXY SILANE ON SILICON-OXIDE*. Journal of Colloid and Interface Science, 1991. **147**(1): p. 103-118.
76. Köhler, M. and W. Fritzsche, *Nanotechnology An Introduction to Nanostructuring Techniques*, ed. WILEY. 2007.

77. Hermanson, G.T., *Bioconjugate Techniques*, ed. A. Press. 2008.
78. Murphy-Perez, E., S.K. Arya, and S. Bhansali, *Vapor-liquid-solid grown silica nanowire based electrochemical glucose biosensor*. *Analyst*, 2011. **136**(8): p. 1686-1689.
79. Wilson, R. and A.P.F. Turner, *GLUCOSE-OXIDASE - AN IDEAL ENZYME*. *Biosensors & Bioelectronics*, 1992. **7**(3): p. 165-185.
80. Bankar, S.B., et al., *Glucose oxidase - An overview*. *Biotechnology Advances*, 2009. **27**(4): p. 489-501.
81. Leskovac, V., et al., *Glucose oxidase from Aspergillus niger: the mechanism of action with molecular oxygen, quinones, and one-electron acceptors*. *International Journal of Biochemistry & Cell Biology*, 2005. **37**(4): p. 731-750.
82. Lonardo, P.M., D.A. Lucca, and L. De Chiffre, *Emerging trends in surface metrology*. *Cirp Annals-Manufacturing Technology*, 2002. **51**(2): p. 701-723.
83. Baena, J.R. and B. Lendl, *Raman spectroscopy in chemical bioanalysis*. *Current Opinion in Chemical Biology*, 2004. **8**(5): p. 534-539.
84. Orsini, F., et al., *FT-IR microspectroscopy for microbiological studies*. *Journal of Microbiological Methods*, 2000. **42**(1): p. 17-27.
85. Garcia, R. and R. Perez, *Dynamic atomic force microscopy methods*. *Surface Science Reports*, 2002. **47**(6-8): p. 197-301.
86. University of Cambridge, C.f.R.i.E.S.a.T.; Available from: <http://www.cheng.cam.ac.uk/research/groups/electrochem/JAVA/electrochemistry/ELEC/12html/12mt.html>.
87. Jackson, A.W.B.a.B.P. *Study of Ferricyanide by Cyclic Voltammetry Using the CV-50W*.
88. Van der Biest, O.O. and L.J. Vandeperre, *Electrophoretic deposition of materials*. *Annual Review of Materials Science*, 1999. **29**: p. 327-352.
89. Huey, E., et al., *Optimized growth and integration of silica nanowires into interdigitated microelectrode structures for biosensing*. *Sensors and Actuators B-Chemical*, 2012. **175**: p. 29-33.

90. Wang, J., et al., *Glucose oxidase entrapped in polypyrrole on high-surface-area Pt electrodes: a model platform for sensitive electroenzymatic biosensors*. Journal of Electroanalytical Chemistry, 2005. **575**(1): p. 139-146.
91. Bai, Y., et al., *Enzyme-free glucose sensor based on a three-dimensional gold film electrode*. Sensors and Actuators B-Chemical, 2008. **134**(2): p. 471-476.
92. Shirsat, M.D., C.O. Too, and G.G. Wallace, *Amperometric glucose biosensor on layer by layer assembled carbon nanotube and polypyrrole multilayer film*. Electroanalysis, 2008. **20**(2): p. 150-156.
93. Yang, Y.L., et al., *Performance characteristic studies of glucose biosensors modified by (3-mercaptopropyl)trimethoxysilane sol-gel and non-conducting polyaniline*. Sensors and Actuators B-Chemical, 2008. **131**(2): p. 533-540.
94. Wang, H.C., et al., *A novel glucose biosensor based on the immobilization of glucose oxidase onto gold nanoparticles-modified Pb nanowires*. Biosensors & Bioelectronics, 2009. **25**(1): p. 142-146.
95. Luo, L.Q., et al., *Amperometric glucose biosensor based on NiFe₂O₄ nanoparticles and chitosan*. Sensors and Actuators B-Chemical, 2010. **145**(1): p. 293-298.

Appendices

Appendix A: The Potentiostat System

The cyclic Voltammetry experiment uses a potentiostat, an electronic instrument, for electro analytical testing. Figure A shows the basic electrical model.

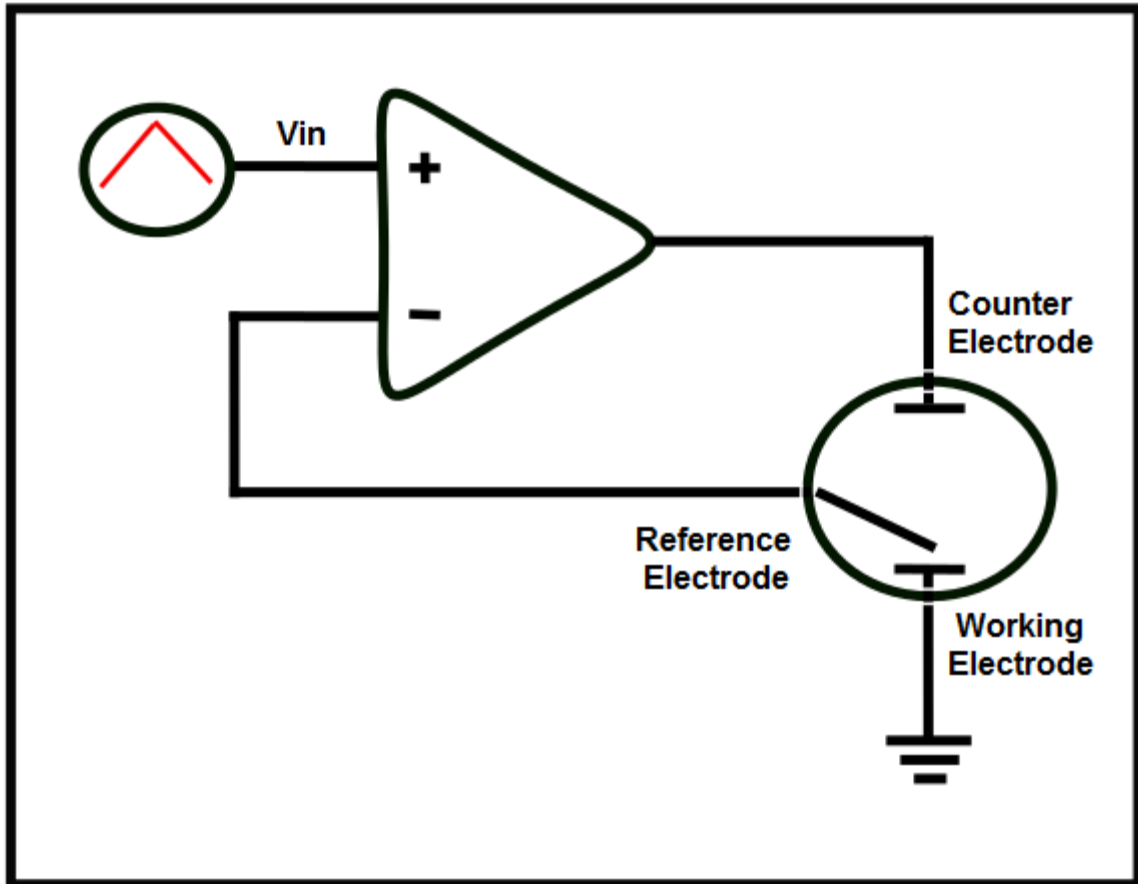

Figure A Electrical model of the potentiostat system

The potentiostat uses three electrodes instead of two. The principle behind is basically to get the reference electrode as close as possible to the working electrode with the objective to eliminate or diminish the drop voltages across the electrolyte solution. The addition of a high impedance connected to the reference electrode, eliminates the chance of having large currents entering or leaving this

Appendix A (Continued)

electrode. This reference electrode is also on the voltage follower configuration.

In Cyclic Voltammetry experiments the value of V_{in} is going to be followed by the Voltage in the reference electrode and the current is going to be supplied by the Counter Electrode.

In Figure B, a short comparison states the difference between a two and a three electrode cell system.

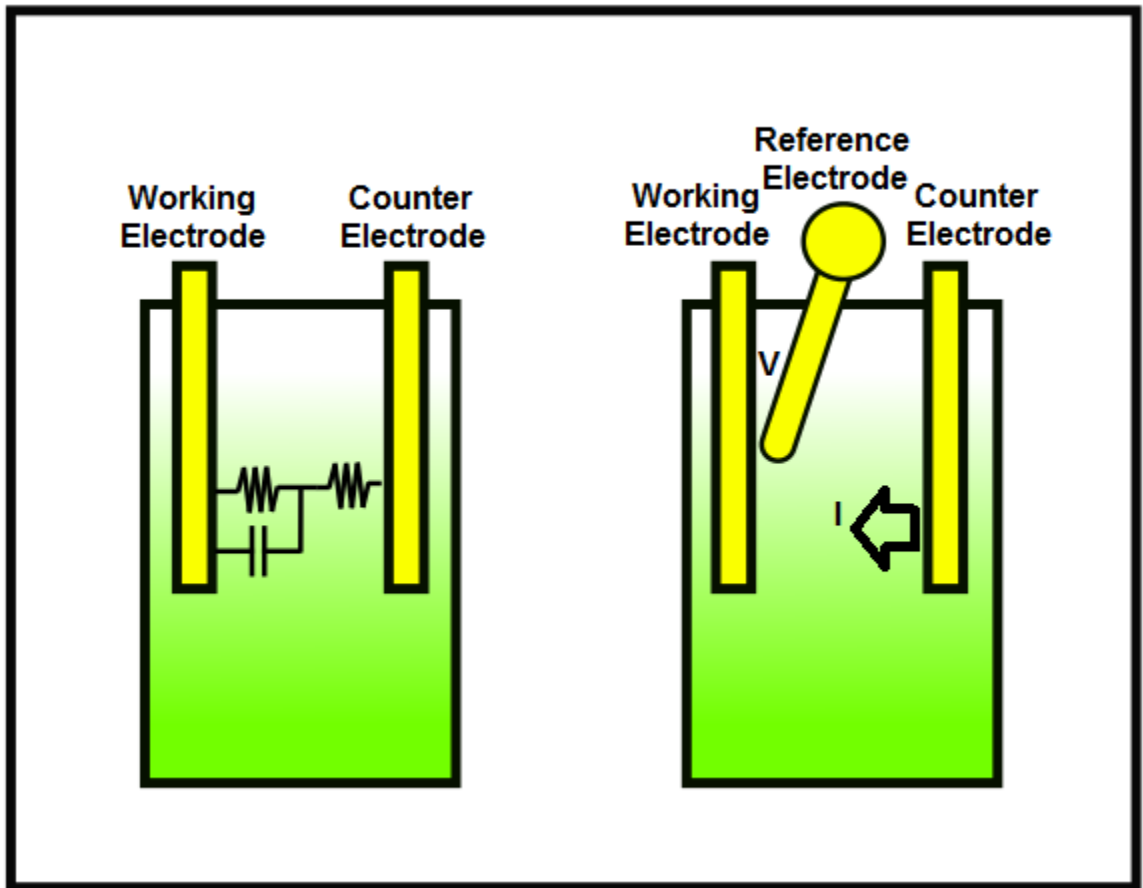

Figure B The difference between two and three electrodes

In the two electrode cell system, the voltage potential is dropped across the electrolyte between both electrodes. In the three electrode cell system, the

Appendix A (Continued)

Counter Electrode serves as a current provider, while the Reference Electrode follows the Voltage induced, and its main use is to control the voltage appearing at the Working Electrode. This control voltage tells the redox species appearing near the working electrode to either oxidize or to be reduced at certain threshold levels. This effect will generate the oxidation and reduction peaks in the CV measurements as shown in Figure C and Figure D.

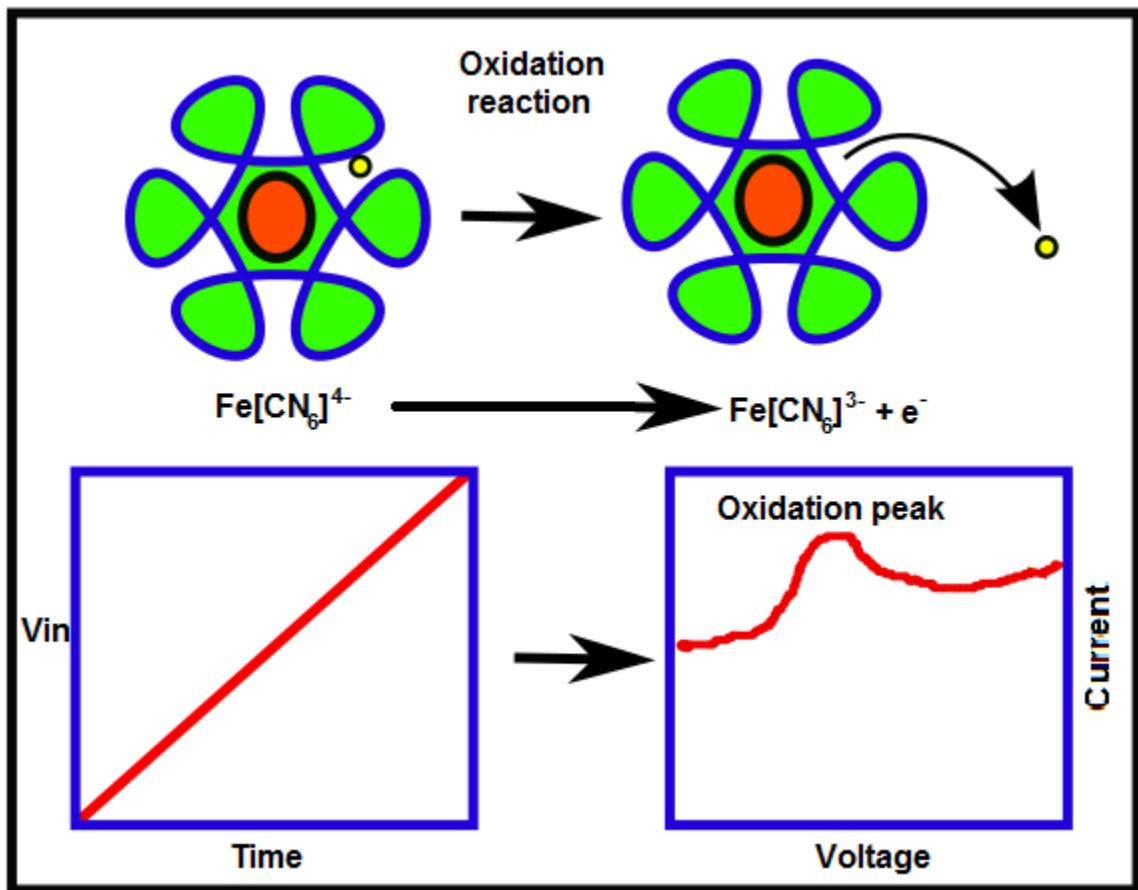

Figure C The oxidation peak of mediators in CV measurements

Appendix A (Continued)

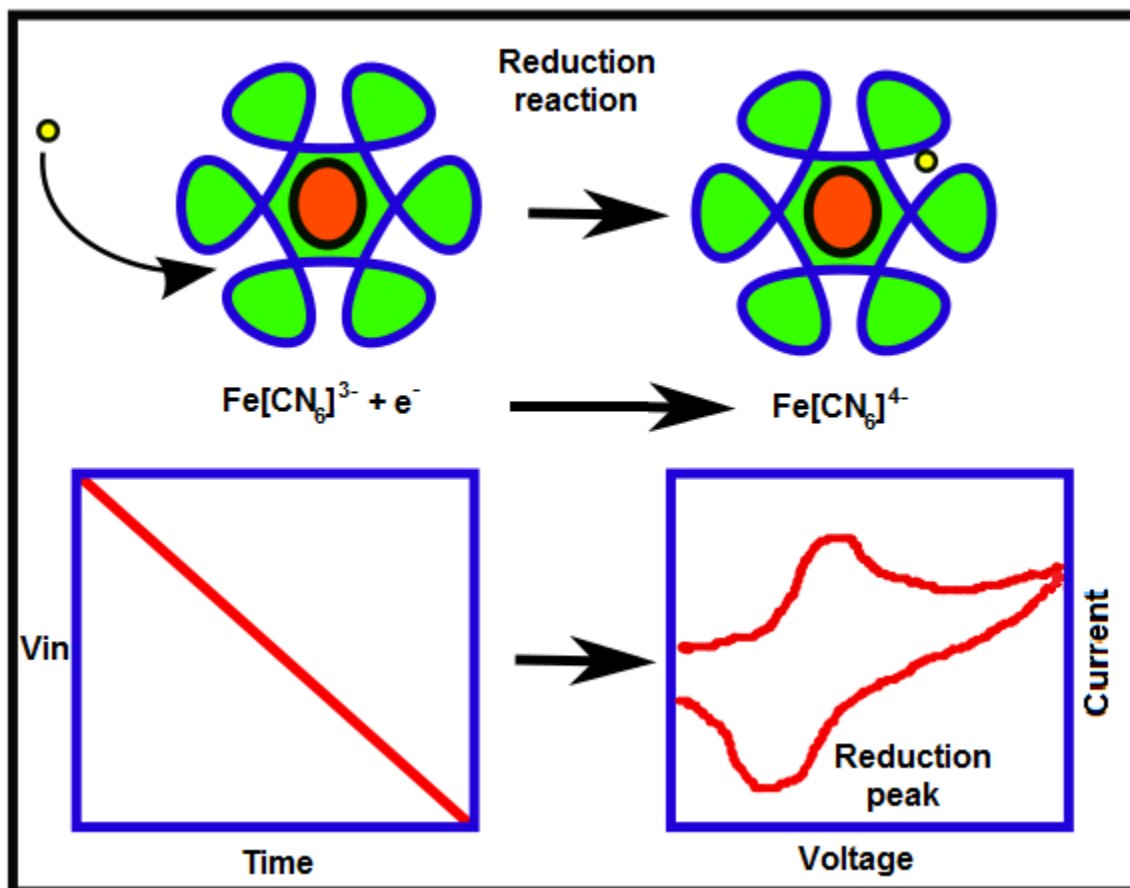

Figure D The reduction peak of mediators in CV measurements

Figure C and Figure D, show the use of the mediator in most electrochemical experiments. The mediator for this work is the redox couple $\text{Fe}[\text{CN}_6]^{4-} / \text{Fe}[\text{CN}_6]^{3-}$. It is very important to recall that in all CV experiments, the reduction and oxidation of this mediator serves as an indirect indicator of the surface conformation in the working area. For example, if the working electrode has dielectric materials that may be interrupting the electron pathway, then the oxidation and reduction peaks will be reduced. However, if the working electrode has an increased surface area to volume ratio with good electric conductivity, then

Appendix A (Continued)

the opposite will happen. For instance, when detecting glucose, GOx process the glucose molecule generating an ionic flux. These electrons can later be transported from the working electrode to the counter electrode causing increased oxidation and reduction peaks which is proportional to the glucose concentration in a specific solution.